

# “Butterfly Bonanza”

*By*

***Nancy Sale***

Lillie Carmichael Evans Elementary  
1895 NW 75 Street  
Miami, Florida 33147  
Phone: (305) 691-4973  
Fax: (305) 691-4867  
Mail Code: 1681

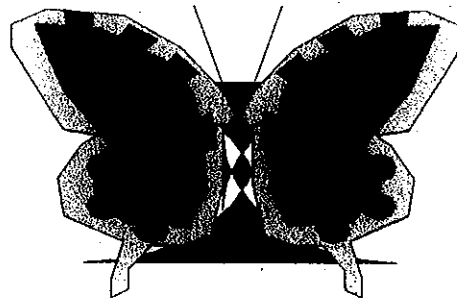



## Table of Contents

<b>Goals &amp; Objectives.....</b>	<b>A</b>
<b>CBC / Sunshine Standards Correlation.....</b>	<b>B</b>
<i>Science.....</i>	<b>B</b>
<i>Reading/Language Arts.....</i>	<b>B</b>
<i>Mathematic/ FCAT Extensions.....</i>	<b>B</b>
<b>Course Outline.....</b>	<b>C</b>
<b>Lesson Plans/Sample Worksheets.....</b>	<b>D</b>
<i>Butterfly Curriculum K-2.....</i>	<b>E</b>
<i>Butterfly Curriculum 3-6.....</i>	<b>F</b>
<i>Literature/ Metamorphosis.....</i>	<b>G</b>
<i>My Butterfly Book.....</i>	<b>H</b>
<i>Bunches of Butterfly Activities.....</i>	<b>I</b>
<i>Center Activities.....</i>	<b>J</b>
<i>Patterns.....</i>	<b>K</b>
<b>Resources.....</b>	<b>L</b>
<b>Bibliography.....</b>	<b>M</b>



## **Goals and Objectives**

**“Butterfly Bonanza” offers a student opportunities they would not normally experience living within the inner city. It provides children with the essential elements of nature and allows them to be in touch with the environment. This nurtures respect and environmental awareness within the child that have a natural carry over into his/her life.**

**Butterflies offer at a glance a full view of the cycle of life and how essential interaction is between plants, animals and people. They provide students with ownership and responsibility because it is their care of the plants and butterflies that ensures the successful completion of the growth cycle.**

**The scientific method and process skills are utilized throughout the many adventures the garden provides. Opportunities to observe, gather information, organize and analyze data are plentiful and carry over into mathematics with the study of charts and graphs. As we know, these are critical elements in the preparation of students for FCAT and the development of higher order thinking skills.**

**In addition, students can carry over their love of butterflies into the classroom through literature and writing. Journals and creative writing are a natural outgrowth of butterflies and gardens. Literature is full of exciting stories with the interwoven theme of butterflies, gardens, and the life cycle.**

**By providing students with this gamut of experiences it is the basic goal of this project to develop in students, academic skills, environmental awareness and a natural respect for living things.**



# Federal, State & County Goals, Standards & Objectives

*Federal*

*Blueprint 2000 Goals*

**Student Performance  
Learning Environment  
Parental Involvement**

*State*

*Florida's System of School  
Improvement & Accountability*

*Goal #3 Standards*

**Information Managers  
Effective Communicators  
Numeric Problem Solvers  
Critical Problem Solvers**

<i>Sunshine State Standards</i>	<i>Competency Based Curriculum</i>
<b>Science</b>	<b>Science</b>
<i>The Nature of Science</i> <i>K-5</i>	<i>Science Process Skills</i> <i>K-5I. A1-8</i>
<i>Processes of Life</i> <i>K-5</i>	<i>Life Science</i> <i>K-5II. A1-5</i>
<i>How Living Things Interact With Their Environment</i> <i>K-5</i>	<i>Environment</i> <i>K-5V. A1-3 K-5V. B1-3</i>
<b>Language Arts</b>	<b>Language Arts</b>
	<i>Reading/ Literature</i> <i>K-5I. A1-9</i>
	<i>Composition</i> <i>K-5II.A1-10</i>
	<i>Listening/ Speaking/Viewing</i> <i>K-5IV.1-10</i>
<b>Mathematics</b>	<b>Mathematics</b>
<i>K-5MA.E.1.2.1 Measurement, Statistics</i> <i>K-5MA.E.2.2.1 Probability &amp; Graphing</i> <i>K-5MA.E.3.2.1</i>	<i>Measurement</i> <i>K-5 IV. A 1</i>

## Course Outline

---

This unit can and should be an ongoing project for any class in the elementary level. The initial introduction, instruction and implementation of the butterfly's life cycle varies with the age group. However, you should allow a minimum of six weeks for students to be able to experience the complete cycle of development. In projects that are ongoing the students can collect data from a variety of species and monitor variations in their growth, development and life cycles.

- I. Preparation
  - Gather appropriate plants to serve as hosts and as nectar sources for each species.
  - Prepare soil and select an area for the butterfly garden.
  - Collect eggs and caterpillars of several species native to your geographic area.
  - Collect a variety of age-appropriate literature with butterfly & garden related themes, (see bibliography)
- II. Introduction
  - Present literature to students.
  - Make plants, eggs and caterpillars available for student exploration.
  - Present *Butterfly Journal* and have students write initial observations, predictions, thoughts and feelings about their exploration.
- III. Instruction
  - Present age appropriate subject matter related to basic concepts of butterflies and their life cycles.
  - Discuss the concept of host plants and nectar sources.
  - Present the various types of plants.
- IV. Implementation
  - Plan and create garden area.
  - Create cooperative learning groups.
  - Make daily observations of the eggs and caterpillars in the garden.
  - Record observations, measurements and data related to changes observed.
  - Discuss and analyze data of changes observed.
  - Research information as to the life cycle of butterflies.
- V. Extensions
  - Create charts and graphs to organize data collected.
  - Write to explain the butterfly's life cycle in publishable form.



## Lesson Plans

A variety of lessons has been compiled within the areas of language arts, science and mathematics. All these lessons are theme related and are appropriate for use within the "Butterfly Bonanza". Sample worksheets and materials are provided for each selected lesson plan.

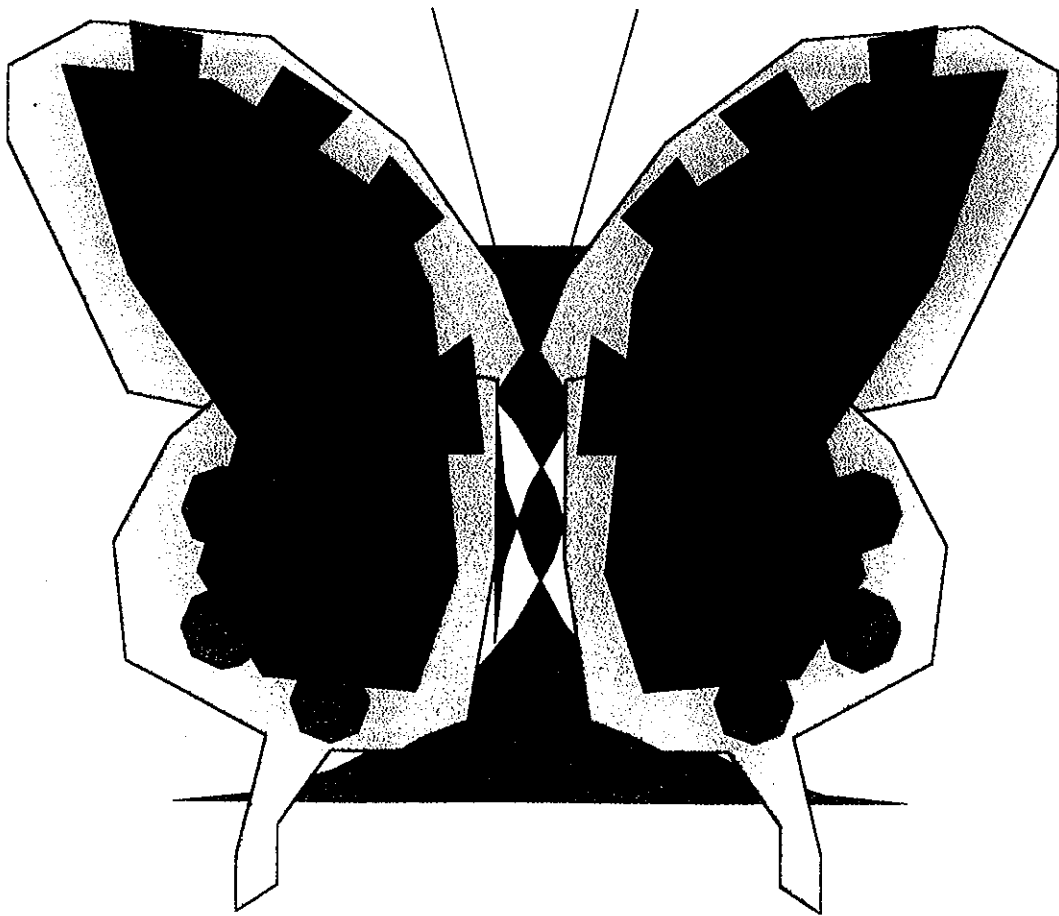



**THE  
BUTTERFLY  
CURRICULUM**

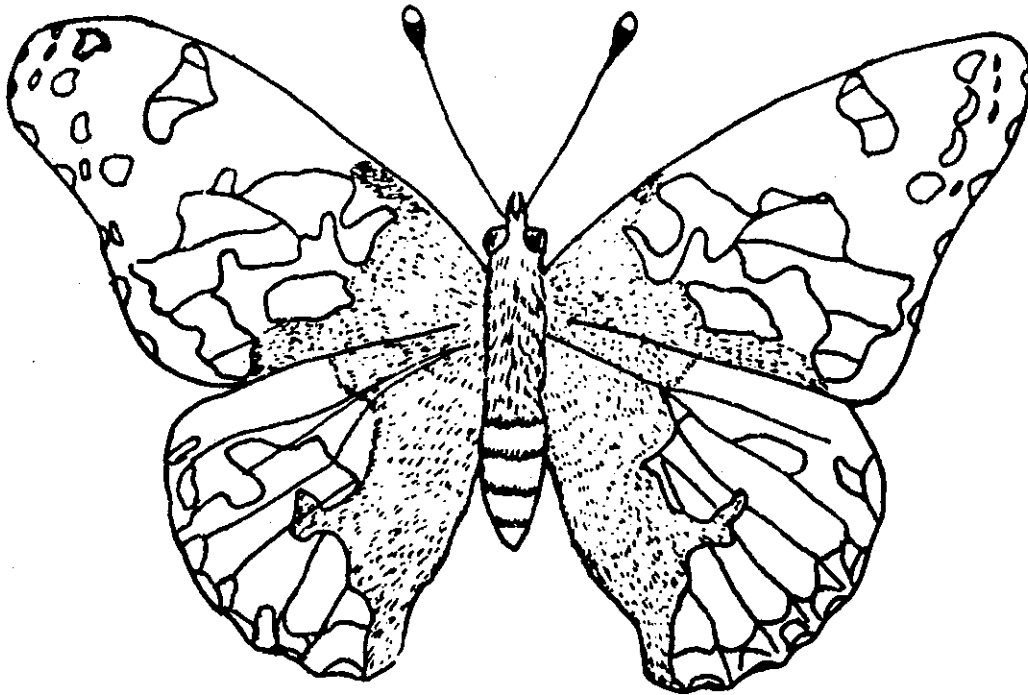

**SUGGESTED ACTIVITIES  
FOR  
KINDERGARTEN THROUGH GRADE TWO  
USING THE  
BUTTERFLY GARDEN® SCHOOL KIT**

## INDEX

Forward.....	1
Suggested Extended Activities .....	2
Suggested Books for Additional Reading .....	3
Learning Objectives and Skills .....	4

### Activity Sheets

LESSON 1 - Let's Grow Butterflies! .....	9
LESSON 2 - The Caterpillar .....	11
LESSON 3 - Find the Parts of Your Caterpillar .....	12
LESSON 4 - The Jobs the Caterpillar Parts Do .....	13
LESSON 5 - Does Your Caterpillar Change? .....	14
LESSON 6 - Name the Stages of a Butterfly .....	15
LESSON 7 - Does Your Caterpillar Grow? .....	16
LESSON 8 - How Many Days from Caterpillar to Butterfly? .....	17
LESSON 9 - Caterpillars Spin Silk .....	18
LESSON 10 - Caterpillars and Butterflies Need Rest .....	19
LESSON 11 - Do Caterpillars Protect Themselves? .....	20
LESSON 12 - What Happens to the Caterpillar? .....	21
LESSON 13 - Butterflies Get Hungry .....	22
LESSON 14 - Find the Butterfly Parts .....	23
LESSON 15 - Butterflies are Insects .....	24
LESSON 16 - Butterfly Wings .....	25
LESSON 17 - Different Kinds of Butterflies .....	26
LESSON 18 - Are You Like a Butterfly? .....	27
LESSON 19 - Write a Story About a Butterfly .....	28
LESSON 20 - Color and Cut Out a Butterfly .....	29
LESSON 21 - A Butterfly Poem .....	30
LESSON 22 - Good Insects and Bad Insects .....	31
LESSON 23 - The Ant Story .....	32
LESSON 24 - The Termite Story .....	33
LESSON 25 - Making a Butterfly Net .....	34
LESSON 26 - A Butterfly Hunt .....	35
Teacher's Guide.....	36

## **FOREWORD**

**The classroom rearing of butterflies provides a strong motivational source of study for developing science skills and understandings. Students want to express themselves as they become excited in witnessing the metamorphosis of the butterflies. This motivating event can be used to develop oral self-expression as well as reading, writing, and even certain math skills.**

**These activity sheets are designed to develop and reinforce science and reading skills. One activity involves students in certain math skills and reasoning.**

## **THE BUTTERFLY CURRICULUM**

**Suggested Activities  
for  
Kindergarten through Grade Two  
using  
The Butterfly Garden\*  
The Butterfly Garden\* School Kit**

**Grateful acknowledgement is expressed to Tom Flanagan, principal of the Richland Primary School, Shafter, California, for his help in the preparation of this unit, and to the Los Angeles City Schools, Instructional Planning Division, for some of the ideas and certain manuscript forms used in this curriculum.**

## SUGGESTED EXTENDED ACTIVITIES

### Science:

1. Grow plants from the seeds of malva, hollyhock, thistle, fiddleneck, or nettle. Later, rear some butterflies on these leaves.
2. Discuss different types of development found in insects.
  - **Direct** development like silverfish. The adult looks the same as the young silverfish with only a difference in size.
  - **Gradual** metamorphosis in insects like grasshoppers. With the exception of the adult grasshopper having wings, both the nymph and the adult are very similar in appearance.
  - **Complete** metamorphosis in insects like butterflies, beetles, flies, wasps, and bees. All have sharply defined stages which look much different from the adult.
3. Study other flying things: birds, bats, insects, flying squirrels (really gliders). There were once even flying reptiles.
  - How are short, stubby wings used? Beaten rapidly, fast fliers.
  - How are large wings used? Beaten slowly, used for gliding.
4. Discuss how a butterfly uses her wings both as lifters and propellers. The veins in the wings are rigid and make the front part of the wing stiff while the back part of the wing bends. During flight, the bending back part of the wing forces air backward and forces the butterfly forward.
5. Dissect a flower to find the nectaries. Discover also the parts of the flower that work together to produce seeds (stamens, anthers, pistils, ovary; also petals, sepals, and stem).

### Reading and Language:

1. Butterfly Crossword Puzzle. (Use words such as eyes, legs, wings, head, body, antennae).
2. How many words can you get out of the word **butterfly** and **caterpillar**?

## SUGGESTED BOOKS FOR ADDITIONAL READING

Color Treasury of Butterflies and Moths. Cresent Books, Division of Crown Publishers, Inc., 419 Park Avenue South, New York, NY 10016.

Most pages of this book are devoted to colored pictures of the more common colorful moths and butterflies. There is an excellent introductory section which gives a great deal of behavioral and morphological back ground on butterflies and an insight into the reasons for such characteristics.

ESS Guide to Butterflies. McGraw-Hill Book Co., Webster Division, 8171 Redwood Highway, Novato, CA 94947.

Many of the suggested activities in this ESS Guide could be used in conjunction with The Butterfly Garden™ School Kit.

Hopf, A.L., Butterfly and Moth, G.P. Putnam and Sons, New York, NY, 1969.

This well-illustrated book describes the development of the spicebush swallowtail and the promethea moth in great detail.

Klots, A.E., A Field Guide to the Butterflies, Houghton-Mifflin Company, Boston, MA, 1951.

This field guide is extensively illustrated with colored pictures of the butterflies in North America. Life histories, including distribution and food plants are given.

Mitchell, R.T., and Zim, H.S., Butterflies and Moths, Golden Press, New York, NY, 1962.

Food plants, colored illustrations of butterflies and moths, as well as many caterpillars and pupae are included in this book.

Sterling, D., Caterpillars, Doubleday & Co., Inc., New York, NY 1961.

This book contains illustrations and descriptions of the life cycles of the more common butterfly species.

**Learning Objectives & Skills for  
The Butterfly Curriculum  
Grades Kindergarten Through Two**

LESSON	SCIENCE OBJECTIVES	READING SKILLS
<p>Lesson 1. Let's Grow Butterflies.</p> <p><b>Understanding:</b> Living things have needs that must be met.</p>	<p>Pupils find a place suitable for their caterpillars and learn procedures which assure the success of their animals.</p> <p><b>Science Skills Include:</b> Careful manipulation of materials.</p>	<p><b>Vocabulary Development:</b> Developing and reinforcing vocabulary. Introduction of special words. Begin word box.</p> <p><b>Comprehension Skills:</b> Following written directions.</p>
<p>Lesson 2. The Caterpillar.</p> <p><b>Understanding:</b> The caterpillar has its own particular characteristics.</p>	<p>Pupils identify characteristics and enter their observations in a drawing.</p> <p><b>Science Skills Include:</b> Observing, identifying and illustrating.</p>	<p><b>Vocabulary Development:</b> Developing and reinforcing vocabulary.</p> <p><b>Comprehension Skills:</b> Following written directions.</p>
<p>Lesson 3. Find the Parts of Your Caterpillar.</p> <p><b>Understanding:</b> Parts of a caterpillar can be found and identified.</p>	<p>Pupils identify the caterpillar parts and associate the parts with names.</p> <p><b>Science Skills Include:</b> Identifying and naming.</p>	<p><b>Vocabulary Development:</b> Developing and reinforcing vocabulary associated with insect terminology. Add words to the box.</p> <p><b>Comprehension Skills:</b> Following written directions.</p>
<p>Lesson 4. The Jobs the Caterpillar Parts Do.</p> <p><b>Understanding:</b> Caterpillar parts perform useful and essential functions.</p>	<p>Pupils relate parts with functions.</p> <p><b>Science Skills Include:</b> Comparing, recording and discussing.</p>	<p><b>Vocabulary Development:</b> Developing and reinforcing vocabulary associated with body parts.</p> <p><b>Comprehension Skills:</b> Following written directions, interpreting information, drawing inferences and conclusions.</p>
<p>Lesson 5. Does Your Caterpillar Grow?</p> <p><b>Understanding:</b> All living things have basic needs.</p>	<p>Growth is directly related to eating good foods.</p> <p><b>Science Skills Include:</b> Observing, recording, comparing and discussing ideas.</p>	<p><b>Vocabulary Development:</b> Developing and reinforcing vocabulary.</p> <p><b>Comprehension Skills:</b> Interpreting information and drawing inferences.</p>
<p>Lesson 6. Name the Stages of a Butterfly.</p> <p><b>Understanding:</b> The butterfly goes through different stages.</p>	<p>Pupils identify the stages in the development of a butterfly.</p> <p><b>Science Skills Include:</b> Comparing.</p>	<p><b>Vocabulary Development:</b> Developing vocabulary and spelling words associated with insect terminology. Add to word box.</p> <p><b>Comprehension Skills:</b> Following written directions.</p>



## SUGGESTED BOOKS FOR ADDITIONAL READING

**Color Treasury of Butterflies and Moths.** Cresent Books, Division of Crown Publishers, Inc., 419 Park Avenue South, New York, NY 10016.

Most pages of this book are devoted to colored pictures of the more common colorful moths and butterflies. There is an excellent introductory section which gives a great deal of behavioral and morphological back ground on butterflies and an insight into the reasons for such characteristics.

**ESS Guide to Butterflies.** McGraw-Hill Book Co., Webster Division, 8171 Redwood Highway, Novato, CA 94947.

Many of the suggested activities in this ESS Guide could be used in conjunction with The Butterfly Garden™ School Kit.

**Hopf, A.L., Butterfly and Moth,** G.P. Putnam and Sons, New York, NY, 1969.

This well-illustrated book describes the development of the spicebush swallowtail and the promethea moth in great detail.

**Klots, A.E., A Field Guide to the Butterflies,** Houghton-Mifflin Company, Boston, MA, 1951.

This field guide is extensively illustrated with colored pictures of the butterflies in North America. Life histories, including distribution and food plants are given.

**Mitchell, R.T., and Zim, H.S., Butterflies and Moths,** Golden Press, New York, NY, 1962.

Food plants, colored illustrations of butterflies and moths, as well as many caterpillars and pupae are included in this book.

**Sterling, D., Caterpillars,** Doubleday & Co., Inc., New York, NY 1961.

This book contains illustrations and descriptions of the life cycles of the more common butterfly species.

**Learning Objectives & Skills for  
The Butterfly Curriculum  
Grades Kindergarten Through Two**

LESSON	SCIENCE OBJECTIVES	READING SKILLS
<p>Lesson 1. Let's Grow Butterflies.</p> <p><b>Understanding:</b> Living things have needs that must be met.</p>	<p>Pupils find a place suitable for their caterpillars and learn procedures which assure the success of their animals.</p> <p><b>Science Skills Include:</b> Careful manipulation of materials.</p>	<p><b>Vocabulary Development:</b> Developing and reinforcing vocabulary. Introduction of special words. Begin word box.</p> <p><b>Comprehension Skills:</b> Following written directions.</p>
<p>Lesson 2. The Caterpillar.</p> <p><b>Understanding:</b> The caterpillar has its own particular characteristics.</p>	<p>Pupils identify characteristics and enter their observations in a drawing.</p> <p><b>Science Skills Include:</b> Observing, identifying and illustrating.</p>	<p><b>Vocabulary Development:</b> Developing and reinforcing vocabulary.</p> <p><b>Comprehension Skills:</b> Following written directions.</p>
<p>Lesson 3. Find the Parts of Your Caterpillar.</p> <p><b>Understanding:</b> Parts of a caterpillar can be found and identified.</p>	<p>Pupils identify the caterpillar parts and associate the parts with names.</p> <p><b>Science Skills Include:</b> Identifying and naming.</p>	<p><b>Vocabulary Development:</b> Developing and reinforcing vocabulary associated with insect terminology. Add words to the box.</p> <p><b>Comprehension Skills:</b> Following written directions.</p>
<p>Lesson 4. The Jobs the Caterpillar Parts Do.</p> <p><b>Understanding:</b> Caterpillar parts perform useful and essential functions.</p>	<p>Pupils relate parts with functions.</p> <p><b>Science Skills Include:</b> Comparing, recording and discussing.</p>	<p><b>Vocabulary Development:</b> Developing and reinforcing vocabulary associated with body parts.</p> <p><b>Comprehension Skills:</b> Following written directions, interpreting information, drawing inferences and conclusions.</p>
<p>Lesson 5. Does Your Caterpillar Grow?</p> <p><b>Understanding:</b> All living things have basic needs.</p>	<p>Growth is directly related to eating good foods.</p> <p><b>Science Skills Include:</b> Observing, recording, comparing and discussing ideas.</p>	<p><b>Vocabulary Development:</b> Developing and reinforcing vocabulary.</p> <p><b>Comprehension Skills:</b> Interpreting information and drawing inferences.</p>
<p>Lesson 6. Name the Stages of a Butterfly.</p> <p><b>Understanding:</b> The butterfly goes through different stages.</p>	<p>Pupils identify the stages in the development of a butterfly.</p> <p><b>Science Skills Include:</b> Comparing.</p>	<p><b>Vocabulary Development:</b> Developing vocabulary and spelling words associated with insect terminology. Add to word box.</p> <p><b>Comprehension Skills:</b> Following written directions.</p>

**Learning Objectives & Skills for  
The Butterfly Curriculum  
Grades Kindergarten Through Two**

LESSON	SCIENCE OBJECTIVES	READING SKILLS
<p>Lesson 7. Does Your Caterpillar Change? <b>Understanding:</b> The caterpillar develops into a butterfly through identifiable steps.</p>	<p>Pupils identify the sequence of the stages in the development of a butterfly. <b>Science Skills Include:</b> Observing, organizing, manipulating materials and discussing ideas.</p>	<p><b>Vocabulary Development:</b> Developing and reinforcing general vocabulary. Add stages to word box. <b>Comprehension Skill:</b> Following written directions, drawing inferences, interpreting information and forming conclusions.</p>
<p>Lesson 8. How Many Days From Caterpillar to Butterfly? <b>Understanding:</b> A certain amount of time is needed for growth.</p>	<p>Pupils discover how many days are required for each stage of the butterflies' development. <b>Science Skills Include:</b> Observing and recording.</p>	<p><b>Vocabulary Development:</b> Developing and reinforcing vocabulary associated with insects. <b>Comprehension Skills:</b> Following written directions, interpreting information. <b>Math Skills:</b> Reinforcement of the addition and subtraction functions.</p>
<p>Lesson 9. Caterpillars Spin Silk. <b>Understanding:</b> Caterpillars spin silk for a reason.</p>	<p>Caterpillars spin silk which aids their survival in Nature. <b>Science Skills Include:</b> Observing and illustrating.</p>	<p><b>Vocabulary Development:</b> Developing and reinforcing general vocabulary. <b>Comprehension Skills:</b> Following written directions and drawing inferences.</p>
<p>Lesson 10. Caterpillars and Butterflies Need Rest. <b>Understanding:</b> All living things need rest.</p>	<p>Caterpillars and butterflies are not always active. Rest is important to all living things for growth and health. <b>Science Skills Include:</b> Observing, recording, and discussing.</p>	<p><b>Vocabulary Development:</b> Developing and reinforcing vocabulary associated with living things. <b>Comprehension Skills:</b> Following written directions and interpreting information.</p>
<p>Lesson 11. Do Caterpillars Protect Themselves? <b>Understanding:</b> Special structures on a caterpillar are important for protection.</p>	<p>Pupils identify different ways caterpillars protect themselves from enemies. <b>Science Skills Include:</b> Locating, identifying and illustrating.</p>	<p><b>Vocabulary Development:</b> Developing and reinforcing vocabulary associated with living things. Add word enemies to word box. <b>Comprehension Skills:</b> Following written directions and interpreting information.</p>
<p>Lesson 12. What Happens to the Caterpillar? <b>Understanding:</b> Each stage of the butterfly has certain needs which must be met.</p>	<p>Pupils arrange a suitable environment for the chrysalis and butterfly. <b>Science Skills Include:</b> Manipulating materials, observing and identifying.</p>	<p><b>Vocabulary Development:</b> Developing and reinforcing vocabulary. Add any new words to word box. <b>Comprehension Skills:</b> Following written directions.</p>

**Learning Objectives & Skills for  
The Butterfly Curriculum  
Grades Kindergarten Through Two**

LESSON	SCIENCE OBJECTIVES	READING SKILLS
<p>Lesson 13. Butterflies Get Hungry!</p> <p><b>Understanding:</b> Butterflies need special food.</p>	<p>Pupils prepare a feeding station and food for their butterflies.</p> <p><b>Science Skills Include:</b> Manipulating materials, observing, recording and identifying.</p>	<p><b>Vocabulary Development:</b> Developing and reinforcing vocabulary. Add new words to word box.</p> <p><b>Comprehension Skills:</b> Following written directions and drawing inferences.</p>
<p>Lesson 14. Find the Butterfly Parts.</p> <p><b>Understanding:</b> The parts of a butterfly can be found and identified.</p>	<p>Pupils identify the butterfly parts and associate them with names.</p> <p><b>Science Skills Include:</b> Identifying, naming and discussing ideas.</p>	<p><b>Vocabulary Development:</b> Developing and reinforcing vocabulary associated with insects. Add words to word box.</p> <p><b>Comprehension Skills:</b> Following written directions and drawing inferences.</p>
<p>Lesson 15. Butterflies are Insects.</p> <p><b>Understanding:</b> Butterflies have identifiable characteristics that classify them as insects.</p>	<p>Pupils identify characteristics of an animal which make it an insect.</p> <p><b>Science Skills Include:</b> Locating, identifying and comparing</p>	<p><b>Vocabulary Development:</b> Developing and reinforcing vocabulary associated with insect terminology. Add words to the word box.</p> <p><b>Comprehension Skills:</b> Interpreting information, drawing inferences and forming conclusions.</p>
<p>Lesson 16. Butterfly Wings.</p> <p><b>Understanding:</b> A butterfly's wings are necessary for its basic needs.</p>	<p>Pupils understand the wings of a butterfly are used to find food, attract other butterflies, and escape from enemies.</p> <p><b>Science Skills Include:</b> Illustrating and discussing.</p>	<p><b>Vocabulary Development:</b> Developing and reinforcing vocabulary.</p> <p><b>Comprehension Skills:</b> Following written directions and drawing inferences.</p>
<p>Lesson 17. Different Kinds of Butterflies.</p> <p><b>Understanding:</b> Recognition between butterflies of the species is essential for survival.</p>	<p>Pupils realize recognition among individuals of a species is an important reason for butterfly differences.</p> <p><b>Science Skills Include:</b> Observing, discussing and comparing.</p>	<p><b>Vocabulary Development:</b> Developing and reinforcing vocabulary skills.</p> <p><b>Comprehension Skills:</b> Following written directions, drawing inferences and interpreting information.</p>
<p>Lesson 18. Are You Like a Butterfly?</p> <p><b>Understanding:</b> Different body parts serve different needs.</p>	<p>Pupils understand different kinds of body parts are needed for different functions of living things.</p> <p><b>Science Skills Include:</b> Observing, recording, comparing and discussing.</p>	<p><b>Vocabulary Development:</b> Developing and reinforcing vocabulary.</p> <p><b>Comprehension Skills:</b> Forming conclusions, interpreting information and drawing inferences.</p>

**Learning Objectives & Skills for  
The Butterfly Curriculum  
Grades Kindergarten Through Two**

LESSON	SCIENCE OBJECTIVES	READING SKILLS
<p>Lesson 19. Write a Story About a Butterfly.</p> <p><b>Understanding:</b> The sequence in the life history of a butterfly.</p>	<p>Pupils use their imagination and reinforce their understanding of a butterfly's life cycle.</p> <p><b>Science Skills Include:</b> Organizing ideas and illustrating.</p>	<p><b>Vocabulary Development:</b> Reinforcing of vocabulary. Add new words to word box.</p> <p><b>Comprehension Skills:</b> Interpreting and recalling.</p> <p><b>Writing Skills:</b> Organization of ideas, letter and word formation, sentence structure and writing.</p>
<p>Lesson 20. Color and Cut Out a Butterfly.</p> <p><b>Understanding:</b> Following directions.</p>	<p>Pupils use motor skills in coloring, cutting out, and pasting a butterfly on a flower.</p> <p><b>Science Skills Include:</b> Manipulating materials and constructing.</p>	<p><b>Vocabulary Development:</b> Reinforcing vocabulary.</p> <p><b>Comprehension Skills:</b> Following written directions and interpreting information.</p>
<p>Lesson 21. A Butterfly Poem.</p> <p><b>Understanding:</b> The perils of a little caterpillar.</p>	<p>Pupils approach the life history of a butterfly through the medium of poetry.</p>	<p><b>Vocabulary Development:</b> Developing and reinforcing vocabulary. New words for word box.</p> <p><b>Comprehension Skills:</b> Interpreting information.</p>
<p>Lesson 22. Good Insects and Bad Insects.</p> <p><b>Understanding:</b> Insects are labeled as good or bad according to their habits.</p>	<p>Pupils realize that some insects are good and others are bad and discover the reasons why.</p> <p><b>Science Skills Include:</b> Value judgements, discussing, comparing and identifying.</p>	<p><b>Vocabulary Development:</b> Developing and reinforcing vocabulary.</p> <p><b>Comprehension Skills:</b> Interpreting information and drawing inferences.</p>
<p>Lesson 23. The Ant Story.</p> <p><b>Understanding:</b> Most of the work of the ants is good and important.</p>	<p>Pupils realize that ants play a useful role in Nature.</p> <p><b>Science Skills Include:</b> Value judgements and discussing.</p>	<p><b>Vocabulary Development:</b> Developing and reinforcing vocabulary through listening. Add words to word box.</p> <p><b>Comprehension Skills:</b> Interpreting information, drawing inferences and forming conclusions.</p>
<p>Lesson 24. The Termite Story.</p> <p><b>Understanding:</b> Most of the work of the termites is good and important.</p>	<p>Pupils realize that termites play a useful role in Nature.</p> <p><b>Science Skills Include:</b> Value judgements and discussing.</p>	<p><b>Vocabulary Development:</b> Developing and reinforcing vocabulary through listening. Add words to word box.</p> <p><b>Comprehension Skills:</b> Interpreting information, drawing inferences and forming conclusions.</p>

**Learning Objectives & Skills for  
The Butterfly Curriculum  
Grades Kindergarten Through Two**

LESSON	SCIENCE OBJECTIVES	READING SKILLS
<p>Lesson 25. Making a Butterfly Net.</p> <p><b>Understanding:</b> Involves pupils in making a butterfly net.</p>	<p>Pupils make a butterfly net that will be used for the Butterfly Hunt.</p> <p><b>Science Skills Include:</b> Manipulating materials and constructing.</p>	<p><b>Comprehension Skills:</b> Following written directions.</p>
<p>Lesson 26. A Butterfly Hunt!</p> <p><b>Understanding:</b> Butterflies can be found in the environment fulfilling their basic needs.</p>	<p>Students go on a hunt for butterflies and other insects. Students learn where to look and practice care in capturing insects.</p> <p><b>Science Skills Include:</b> Manipulating materials, observing and locating.</p>	<p><b>Comprehension Skills:</b> Following written directions.</p>

Name: \_\_\_\_\_

## Let's Grow Butterflies!

You will need these things:

a caterpillar



the caterpillar's food



caterpillar cup and lid

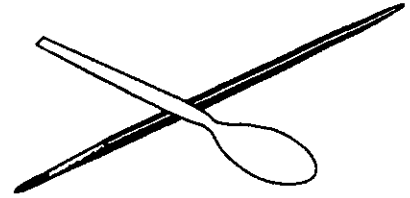

one brush and one spoon

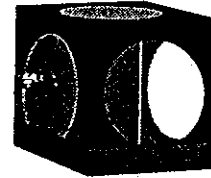

Butterfly Garden™

**Step 1:** Use the spoon to put the caterpillar food into the cup. Fill the cup one-third full. Push it to the bottom of the cup.



**Step 2:** Carefully, pick up the caterpillar with the brush and tap it into the cup.

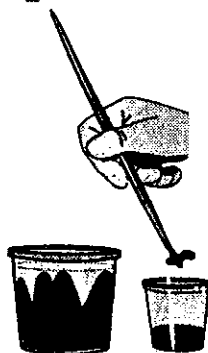

Name: \_\_\_\_\_

## Let's Grow Butterflies! (Continued)

Step 3: Put the lid on the cup. The caterpillar now has a home and food. Your caterpillar has enough air in his new home.



Step 4: Put the Butterfly Garden® box together. Your teacher can help. This will be the home for your butterflies. Put the caterpillar cup on the floor of the Butterfly Garden® if you wish. Write your name on the lid of the cup.

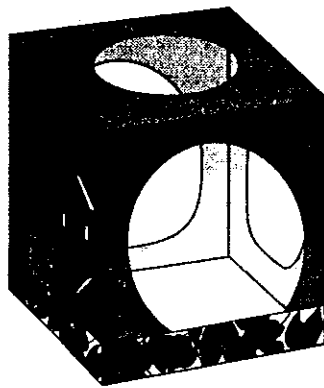

While you watch your caterpillars grow, **here are some things to remember:**

You must not turn the caterpillars upside down.

Try not to drop your caterpillars.

Do not keep the caterpillars too hot or too cold.



Name: \_\_\_\_\_

## The Caterpillar

Step 1: Look at your caterpillar very carefully.

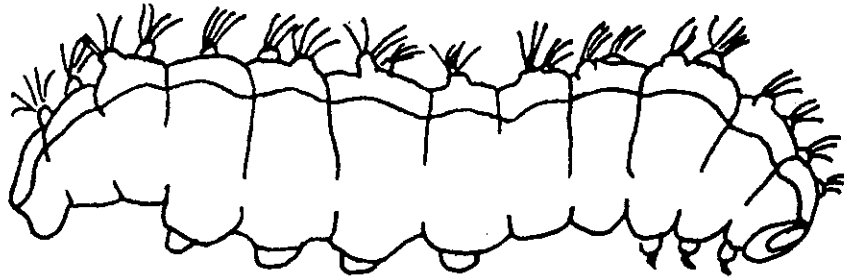

What do you see?

Step 2: Draw a picture of your caterpillar.

Can your caterpillar walk? \_\_\_\_\_

How do you know? \_\_\_\_\_

Can your caterpillar eat? \_\_\_\_\_

Does your  do other things? \_\_\_\_\_

Name: \_\_\_\_\_

## Find the Parts of Your Caterpillar

A  has many parts.

Each part helps the caterpillar.

Each part does something different.

Draw a line from the word to the part on the

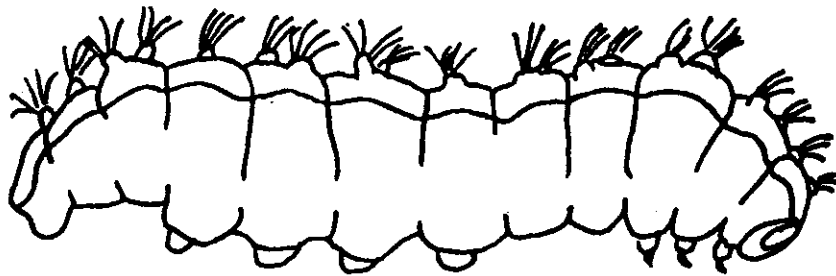

Head      Eyes      Mouth      Body      Fur      Tail

Do you have the same parts? \_\_\_\_\_

Do you have the same number of legs? \_\_\_\_\_

Talk about your ideas.

Name: \_\_\_\_\_

## The Jobs the Caterpillar Parts Do

Draw a line from the part to what it does.

eye

mouth

fur

legs

eats food and spins silk

keeps birds from eating it

looks for food and things

moves the insect

The  has \_\_\_\_\_ legs.

The  has \_\_\_\_\_ eyes.

The  has \_\_\_\_\_ mouth.

Do you have the same number of:

Eyes? \_\_\_\_\_

Legs? \_\_\_\_\_

Mouths? \_\_\_\_\_

In what ways are you and the caterpillar different?

---

Talk about your ideas.

Name: \_\_\_\_\_

## Does Your Caterpillar Grow?

Watch your  every day.

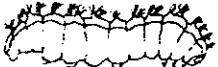
Does your  eat?

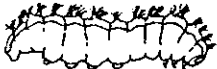
Does your  grow?

Who grows the fastest? \_\_\_\_\_ Who grows biggest? \_\_\_\_\_

Does the  need good food to grow? \_\_\_\_\_

Do you need good food too? \_\_\_\_\_

What are some good foods for you to eat?

_____	_____	_____
_____	_____	_____
_____	_____	_____

Should you eat a good breakfast? \_\_\_\_\_ Why? \_\_\_\_\_

\_\_\_\_\_

What did you have for breakfast this morning? \_\_\_\_\_

\_\_\_\_\_

Talk about good foods.

Name: \_\_\_\_\_

## Name the Stages of a Butterfly

Draw a line from the name to its picture.

egg

caterpillar

chrysalis

butterfly

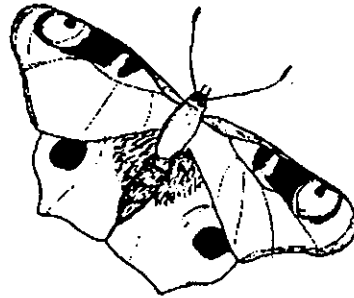

The caterpillars of butterflies make chrysalides. The caterpillars of moths make cocoons. A cocoon has silk around it. A chrysalis doesn't have silk around it.

Print these words:

egg

\_\_\_\_\_

caterpillar

\_\_\_\_\_

chrysalis

\_\_\_\_\_

butterfly

\_\_\_\_\_

Watch for these stages as your caterpillar grows!

Name: \_\_\_\_\_

## Does Your Caterpillar Change?

A  is an insect.

Most insects change as they grow.

We call these changes stages.

The stages in the growth of a  are the egg, the caterpillar, the chrysalis and the butterfly.

Cut out the pictures and place them in a row.  
Which comes out first, second, third and fourth?

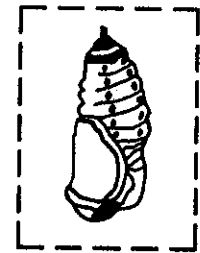
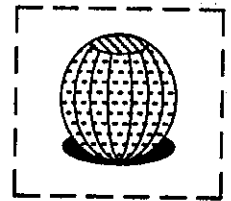
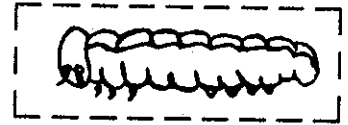
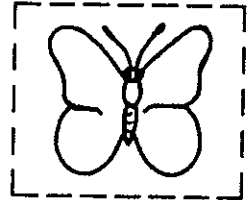

Could you place the pictures in a circle? \_\_\_\_\_





Would this be better than a straight row? \_\_\_\_\_

Why/why not? \_\_\_\_\_

Talk about your ideas.

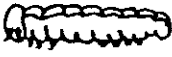
Name: \_\_\_\_\_

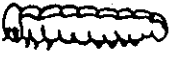
## How Many Days From Caterpillar to Butterfly?

A  must eat and grow before it can become a  .  
How long do you think it takes a  to become a  ?

Put the day of the month you received your caterpillars here: \_\_\_\_\_

Next, put the day of the month your caterpillars changed into chrysalides here: \_\_\_\_\_

Now put the day of the month your butterflies came out of the chrysalids here: \_\_\_\_\_

### Answer these questions:

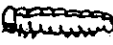
How many days before the  became a chrysalis? \_\_\_\_

How many days before the  became a butterfly? \_\_\_\_

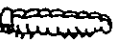
How many days before the  became a butterfly? \_\_\_\_

Which stage of the butterfly lasted longest? \_\_\_\_\_

Which stage was the shortest? \_\_\_\_\_

Which stage did you like the best? \_\_\_\_\_

Name: \_\_\_\_\_

## Caterpillars Spin Silk

Caterpillars spin silk from their mouths.



When the caterpillar moves its head from side to side, it is spinning silk.

Look at the silken threads with a magnifying glass.

See how the threads cross each other.

Draw a picture of the silken threads.

Caterpillars walk on the threads like a ladder.

The caterpillar's feet have tiny hooks which hold on to the threads.

Would the silk keep the caterpillar from falling?

Can you think of another insect that spins silk?



Do we use silk for anything?



Name: \_\_\_\_\_

## Caterpillars and Butterflies need Rest

Watch your  closely.

Write down some of the things the  does.

---

---

---

Is your caterpillar quiet sometimes?

When the  is quiet, he is resting or asleep.

The  needs rest.

Do you need rest sometimes? \_\_\_\_\_

What happens when you do not rest? \_\_\_\_\_

Everyone needs rest and sleep. When we are resting or sleeping, our bodies can grow and change.

Does your caterpillar's body grow and change? \_\_\_\_\_

When your butterfly comes out of the chrysalis, watch to see if it rests sometimes.

Name: \_\_\_\_\_

## Do Caterpillars Protect Themselves?

Caterpillars have enemies.

Can you think of any caterpillar enemies? \_\_\_\_\_

---

Caterpillars need to protect themselves.

Draw some pictures to show how caterpillars protect themselves.

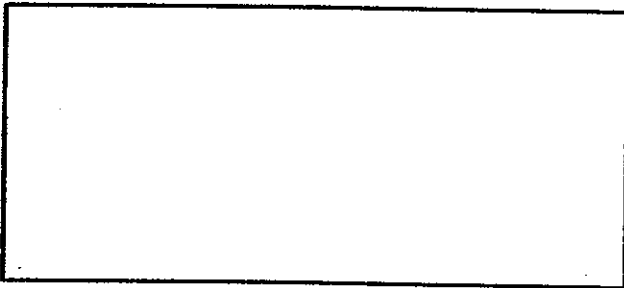

This orange and brown caterpillar tastes bad.

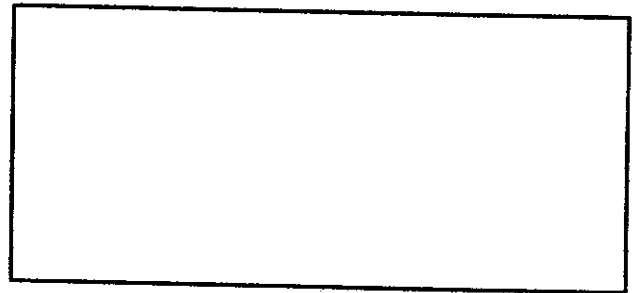

This caterpillar has big horns which frighten enemies.

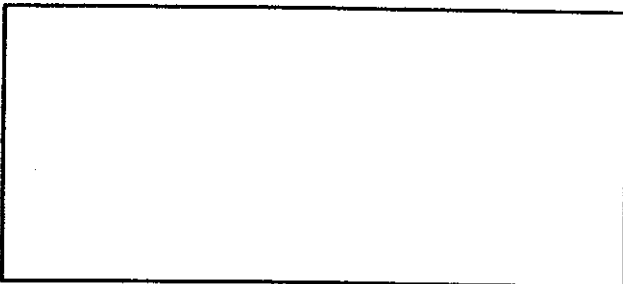

Some brown caterpillars look like brown twigs.

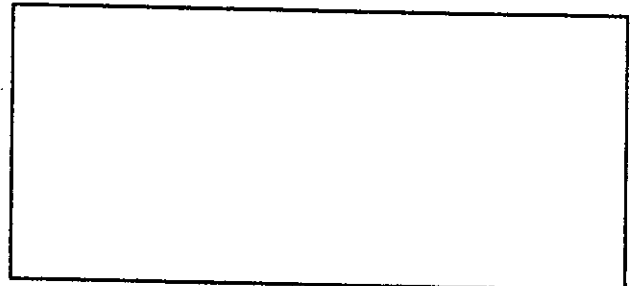

Some caterpillars are hairy and hard for birds to swallow.

Name: \_\_\_\_\_

## What Happens to the Caterpillar?

When your caterpillar gets big, watch him carefully. Your caterpillar will crawl to the top of his cup and hang down.



Next, the skin splits along his back.

Under the skin is the chrysalis. Soon the chrysalis becomes hard and changes to a pretty golden or silver color.

Take the lid off the cup.

Put the lid with the chrysalis into the box very carefully. This is a waiting time for you, but the butterfly is very busy.

When the butterfly comes out of the chrysalis, what parts will it have? Circle them.

eyes

antennae

wings

mouth

legs

head

Did the caterpillar have all of these parts?

Name: \_\_\_\_\_

## Butterflies Get Hungry!

Your butterfly will want to eat.

Step 1. Put the cotton wick in the paper flower in your Butterfly Garden® box.

Step 2. Make some sugar water and put it on the wick with an eyedropper.

For more food for your butterfly, fill an empty jar lid with sugar water. Fold a paper towel and put it in the lid.

Change the sugarwater and paper towel every two days.

How does the butterfly eat? \_\_\_\_\_

Does the butterfly have a long tube? (proboscis) \_\_\_\_\_

Where is the long tube when the butterfly is not using it?  
\_\_\_\_\_

Can a butterfly eat the same food a caterpillar eats? \_\_\_\_\_

Can a caterpillar eat the same food a butterfly eats? \_\_\_\_\_

Name: \_\_\_\_\_

## Find the Butterfly Parts

Look closely at the butterfly.

Draw a line from the butterfly part to its name.

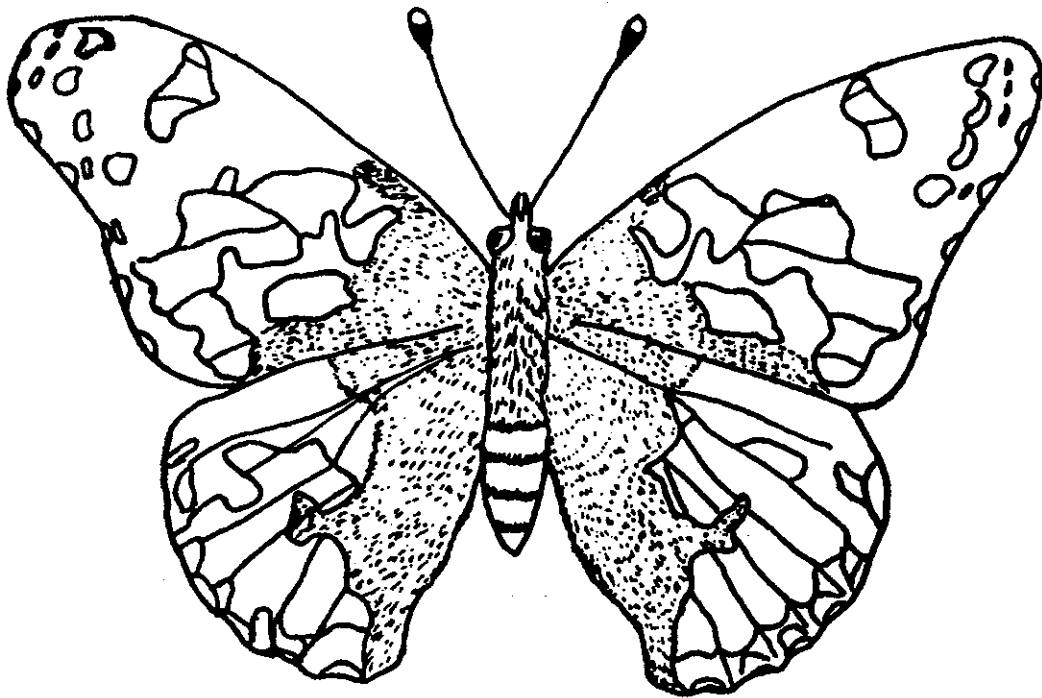

Head

Wing

Antenna

Body

Eye

Do you see any other parts? \_\_\_\_\_

What do the butterfly parts do? \_\_\_\_\_

\_\_\_\_\_  
\_\_\_\_\_

Talk about your ideas.

Name: \_\_\_\_\_

## Butterflies Are Insects

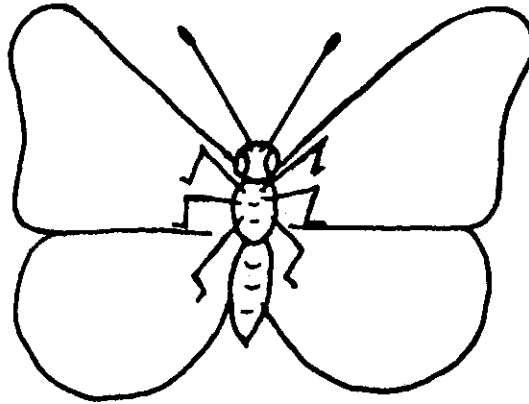

Not all animals are insects.

An animal is an insect if it has these things.

- 6 legs
- 3 body parts (head, thorax and abdomen)
- 4 wings (when it has wings)
- 2 antennae
- 2 eyes

Is a butterfly an insect? \_\_\_\_\_ Why? \_\_\_\_\_

Here is a picture of a spider.

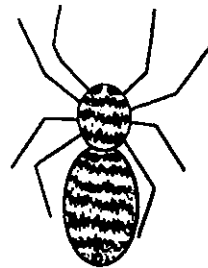

Is the spider an insect? \_\_\_\_\_

Explain your answer. \_\_\_\_\_

Name: \_\_\_\_\_

## Butterfly Wings

Butterflies use their wings for many things.

Can you think of a way a  uses her wings?

Draw some pictures showing how  use their wings.

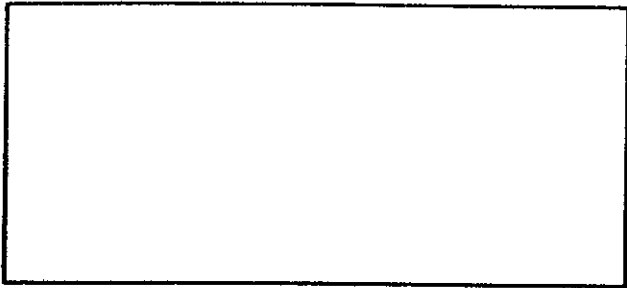

This butterfly is using her wings to fly to flowers.

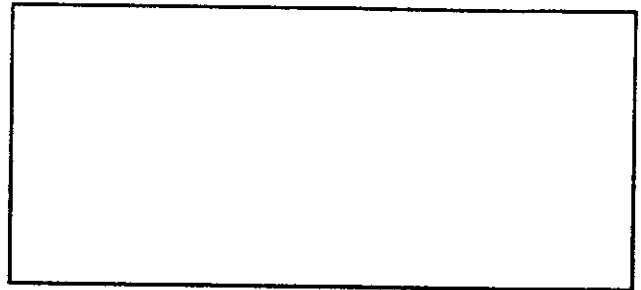

This butterfly is opening her wings so other butterflies can see her

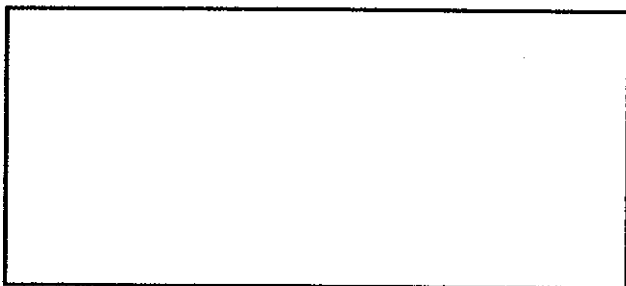

This butterfly is flying away from a bird.

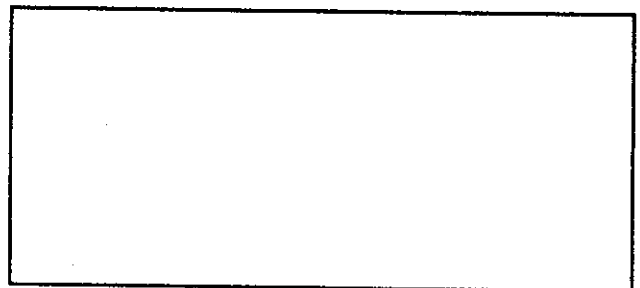

This butterfly has wings which look like a leaf. She is fooling enemies.

Are the butterfly's wings important to her? \_\_\_\_\_

Name: \_\_\_\_\_

## Different Kinds of Butterflies

Look at some pictures of butterflies.



Do they look different? \_\_\_\_\_

Is it important for a  to find its own kind of butterfly?

\_\_\_\_\_

Butterflies must find their own kind of butterflies before they can lay their eggs.

How can a butterfly know the right kind of butterfly? \_\_\_\_\_

\_\_\_\_\_

Name some kinds of butterflies: \_\_\_\_\_

\_\_\_\_\_

What is your favorite kind of butterfly? \_\_\_\_\_



Name: \_\_\_\_\_

Are You Like a Butterfly?

Answer these questions:

I have how many?

\_\_\_\_\_  
\_\_\_\_\_  
\_\_\_\_\_  
\_\_\_\_\_

A Butterfly has how many?

legs  
eyes  
wings  
arms

\_\_\_\_\_  
\_\_\_\_\_  
\_\_\_\_\_  
\_\_\_\_\_

Does a butterfly need wings? \_\_\_\_\_

Does a butterfly need arms? \_\_\_\_\_

Do you need arms? \_\_\_\_\_

Do both you and a butterfly need eyes? \_\_\_\_\_





Do butterflies need special parts to find food and get away from enemies? \_\_\_\_\_

What parts does a butterfly use to find food? \_\_\_\_\_

\_\_\_\_\_

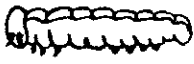
Name: \_\_\_\_\_



## Write a Story About a Butterfly



A  lays eggs which hatch into tiny caterpillars. The furry caterpillar eats leaves, and grows big. When the  is big, it turns into a chrysalis. The beautiful  comes out of the chrysalis. The  stretches its wings and is ready to fly. The  drinks the sweet nectar from the flowers. The  lays eggs on leaves which hatch into caterpillars.



Write a make-believe story about a  you like very much! Use the other side if necessary.



Name: \_\_\_\_\_

## Color and Cut Out a Butterfly

Step 1. Color the  and the  with pretty colors.

Step 2. Cut out the  and the .

Step 3. Bend the  along the dotted line and paste it on the .

Step 4. Paste the  with the  to a piece of colored paper.

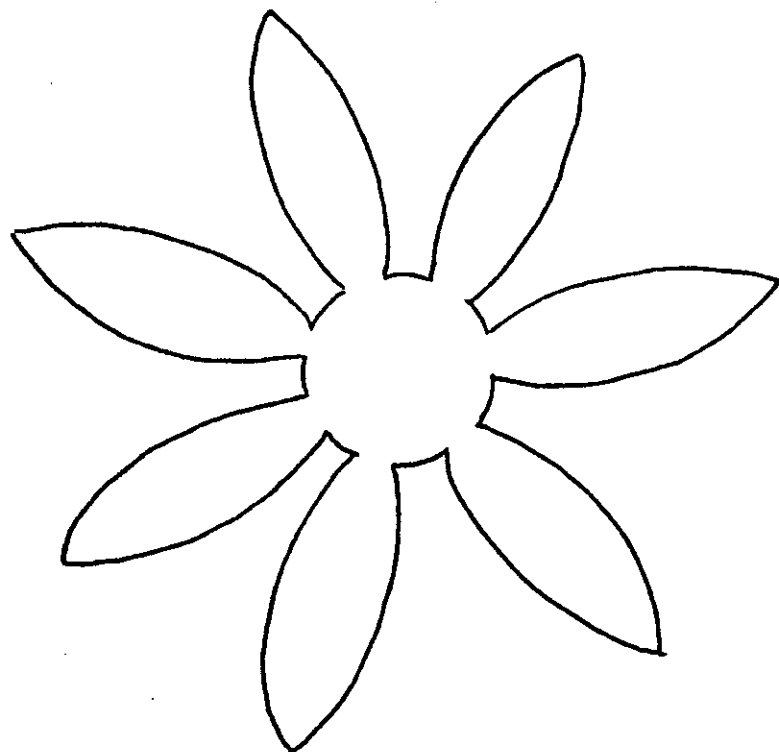
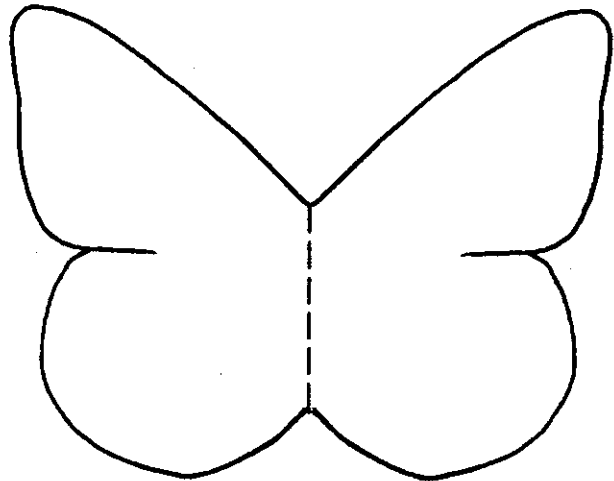

Name: \_\_\_\_\_

## A Butterfly Poem

Do you like poems?

Most students like to read and write poems.

Here is a poem about a .

Furry and brown  
on the ground  
Caterpillar inside  
a leaf you must hide.

So no birds will spy you  
but fly on by you  
Quietly now you lie  
'Till one day I see ....a butterfly!

*Chris R. Lids*

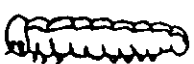
What color was the ? \_\_\_\_\_

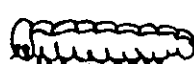
Where did the  hide? \_\_\_\_\_

What enemy did the  have? \_\_\_\_\_

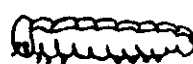
What did the  finally become? \_\_\_\_\_

Name: \_\_\_\_\_

## Good Insects and Bad Insects

Some insects are good and some insects are bad.

Some insects do good things, like:

Eat bad insects

Pollinate flowers

Make honey

Change dead plants and animals into soil



Some insects do bad things, like:

Eat our food

Bite us

Make us sick

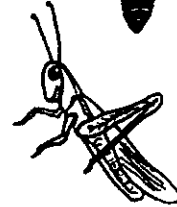

Here are some insects. Tell if they are **good** or **bad**.

Ladybug \_\_\_\_\_

Ants \_\_\_\_\_

Mosquito \_\_\_\_\_

Grasshoppers \_\_\_\_\_

Honeybee \_\_\_\_\_







Praying Mantis \_\_\_\_\_

Can you tell why they are good or bad? \_\_\_\_\_

Can you think of any other good or bad insects? \_\_\_\_\_

Name: \_\_\_\_\_

## The Ant Story

Once upon a time, a grasshopper grew old and died. Along came an ant and found the . The  ran back to his friends and told them about the grasshopper. The ants followed the little ant to where the grasshopper lay. Together, they picked up the  and carried it to their nest, which was not far away. For many days, the  ate the  and fed their little ants from it. As they ate the grasshopper, they changed it back into nice rich soil. The very next spring, new plants grew on this new soil. The plants that grew were good food for ,  and even grasshoppers!

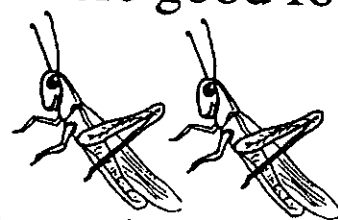

Did the ants do a good thing when they changed the  into soil? \_\_\_\_\_ Why? \_\_\_\_\_

Sometimes  get into your kitchen. Are they good when they do this? \_\_\_\_\_

Why? \_\_\_\_\_

## Making a Butterfly Net

You will need:

- 1 piece of nylon netting or organdy, 2 feet by 3 feet
- 1 coat hanger
- 1 broomstick or 3/4 inch dowelling, 4 feet long

Step 1. Fold netting in half.



Step 2. Cut folded netting.

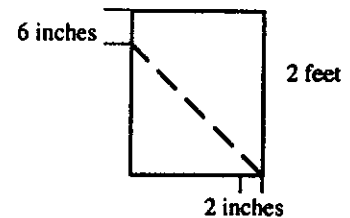

Step 3. Unfold and make 3 inch hem at top.

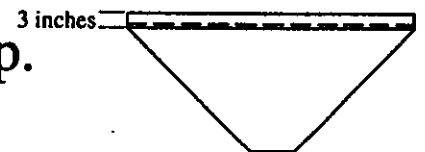

Step 4. Fold again and sew together.

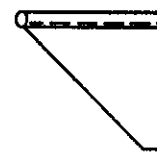

Step 5. Straighten a hanger, bend in a circle and thread through hem.

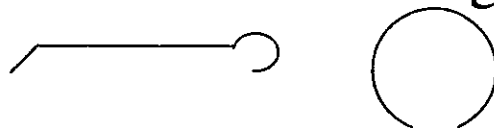

Step 6. Bend ends to fit handle.

Step 7. Tape wire to handle.

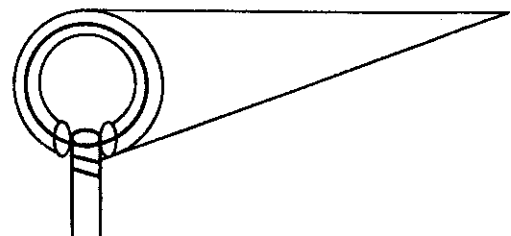



Name: \_\_\_\_\_

## A Butterfly Hunt!

Let's go hunting ..... for butterflies!



You will need:



Quiet voices 





Butterfly nets 



Sharp eyes 



Butterfly Garden™ box 



The best place to find a  is near a . When you

find a  be very . Walk slowly up to the .

Drop the net over the  to catch the . Hold the tip of the  up. The  will go up to the tip. Hold the

 gently through the net. Like this . Use your

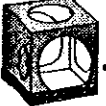
other hand to take the  out very carefully. Put the 

in the . Bring in some  and  from the plant

the  was on. Put the  in the  with the 

and .

How many kinds did you find? \_\_\_\_\_



## TEACHER'S GUIDE

Make a word box and include new words in it as you proceed in these activities.

### Lesson 1

Students should be cautioned to handle the caterpillar cups carefully. The nutrient will sometimes dislodge and crush the larvae. Pack the nutrient snugly in the bottom of the cup to prevent this.

The caterpillars can take a fairly wide range of temperatures. Keep the cups out of direct sun and don't let them freeze.

Transfer the chrysalides into the Butterfly Garden™ box after they form and harden. If the chrysalides have dropped from the lids of the cups, gently pick them up and make the transfer. To give the newly emerged butterflies a good foothold to hang while expanding their wings, a 2" strip of paper toweling can be taped to the sides next to the bottom of the box. The butterflies will not be hungry immediately after emerging. Like a baby chick, they have food stored in their bodies for the first day or two after emergence. Pick the warmest part of the day and preferably release them near some flowers.

### Lesson 2

Encourage the students to look carefully at their caterpillars through the transparent cups. Notice the first three pairs of legs (true legs) look different from the stump-like legs (false legs) found on the back half of the body. The tiny eyes are located just above the mouth on either side of the head. The body of the caterpillar is divided into sections (segments).

### Lesson 3

Self-explanatory.

### Lesson 4

It is important for the students to realize that the caterpillar parts help the caterpillar successfully live in its environment. The specially developed legs allow it to hold onto leaves. The special kind of mouth is perfect for eating the edges of a leaf. The fur (setae) make the caterpillar hard for a bird to swallow. The parts of our body are much different, but just right to help us live successfully in our environment.

### Lesson 5

The emphasis here is on the right kinds of food. Without the right kind of food, the caterpillar could not grow and would soon die. Caterpillars are much more finicky about their food than are people. We eat a variety of foods necessary for us if we are to grow and stay healthy. The food plant, malva, is the principal ingredient of the nutrient on which the caterpillars are feeding. This is the only food needed by the caterpillars.

### Lesson 6

The metamorphosis of a butterfly is a source of fascination for students. With this interest it is fun to learn the names of the different stages in the butterfly's development. Through this motivational source, practice in letter formation and spelling can result.

### Lesson 7

Read the information contained in Lesson 17 to the students before asking them to do this activity. This lesson requires reasoning and some background information on the stages of a butterfly's life. Try to lead the students' reasoning and some background information on the stages of a butterfly's life. Try to lead the students' reasoning from arranging the stages in a single row to the more complex, but total idea, of placing the stages in a circle. The students should realize that one stage was produced from a prior stage while at the same time giving rise to the next stage.

## TEACHER'S GUIDE

### Lesson 8

Entry dates for the arrival date of the caterpillars, their transformation to chrysalides, and finally the butterfly emergence, must be placed in the spaces provided. This activity will be completed approximately 17 - 20 days after the arrival of your caterpillars. The students are really interested in knowing how long it takes for a caterpillar to become a butterfly. Both addition and subtraction are involved in computing the answers to these questions.

### Lesson 9

Almost all caterpillars spin silk. Some spin more freely than others. The important fact for the students to realize is that this is but another characteristic of caterpillar behavior which helps it to survive in its environment. We take advantage of this characteristic to make silk cloth from the silken threads spun by the silkworm.

### Lesson 10

All living things need rest. Animals rest in different ways. Many small animals often rest for a few minutes and are then active for a few minutes. Larger animals often need extended periods of rest or sleep. These long periods of rest are often followed by long periods of activity. The important point is that we all need rest and sleep to give our bodies time to restore needed nourishment, repair tiny damages to our bodies, and to give us a chance to grow when we are young.

### Lesson 11

In Nature, all animals have developed means by which they protect themselves from larger animals. Such ploys as body colors resembling their surroundings (chameleons), mimicking the appearance of other animals which are not good to eat (Viceroy butterfly mimics the Monarch), making themselves look bigger or more ferocious than they really are (cats make themselves appear larger by making their hair stand up), being able to run very fast (rabbits and deer) are just some of the ways animals protect themselves. Caterpillars use some of these ways to protect themselves, too. The better an animal is at protecting itself, the more efficient the animal using it as food must become in capturing it. This makes both animals more nearly perfect. Nature is designed to create the best possible living things!

### Lesson 12

Self-explanatory.

### Lesson 13

Self-explanatory.

### Lesson 14

Emphasize the usefulness the butterfly parts have in making the butterfly successful in its environment. The wings carry the butterfly quickly over long distances to find food and certain plants on which to lay eggs. The legs are built especially to hang onto flowers or leaves. The taste buds are even on the tips of the second and third pairs of legs! This allows the butterfly to find out whether there is a source of nectar in the flower without uncoiling the long proboscis. The long, flexible proboscis can be worked into the smallest opening to reach the flower nectar. The eyes see color very well and with them the butterfly can very successfully find flowers. The eyes see movement very well and can quickly dodge a would-be predator.

### Lesson 15

This lesson gives the students the knowledge necessary to tell whether an animal is an insect. Spiders, ticks, pill bugs, centipedes, and millipedes are some animals confused with insects. These are closely related arthropods.

### Lesson 16

This activity is meant to inform the students that butterfly wings serve not only to carry the butterfly wherever it wants to go, but also are used to attract other butterflies, to escape from enemies, and to conceal the butterfly when she is resting. The wings sometimes have large eyespots used to fool the butterfly's enemies.

## TEACHER'S GUIDE

### **Lesson 17**

There is purpose in the differences between species of butterflies. The primary reason that each butterfly looks the same as other members of its own species and different from any other species is recognition for mating. Wing design and coloration may also serve as camouflage or for frightening would-be enemies. The Buckeye butterfly has large eyespots on the wings which cause birds to confuse them for a larger animal. Some butterfly wings resemble a leaf when they are folded together. Some butterflies are brightly colored (Monarch) and taste bad. A bird attempts to eat the butterfly but once thereafter, the bright colors are remembered as bad by the bird.

### **Lesson 18**

This lesson contrasts the butterfly parts with our own body parts and as a corollary part of the lesson, the reason for these differences.

### **Lesson 19**

In writing the story about a butterfly, encourage the students to give some details; i.e., the color of the butterfly? What time of the year was it? What did you see the butterfly do? Suggest that the students draw some pictures for the story.

### **Lesson 20**

Self-explanatory.

### **Lesson 21**

This simple little poem tells the story of a butterfly. This should be enjoyable for your students.

### **Lesson 22**

Like most large animal groups in Nature, there are those species regarded as beneficial and those which are harmful. Our standard for determining this is what direct effect their activities have upon us. In a raw, natural setting in which modern man is not included, many of the so-called bad insects would fit nicely into the scheme of Nature and would actually compliment it. Ask the students what we do about bad insects. Sometimes we have to spray them with poisons to kill them. Sometimes we can spray them with their own diseases to kill them. Poisoned baits are used for some bad insects. Many times good insects, like lady bugs, come and eat the bad insects.

### **Lesson 23**

The emphasis here is that ants are an important and useful part of Nature. Many youngsters grow up with the thought that ants are bad because they sometimes invade our kitchens in search of food. In the great framework of Nature, they are literally the vacuum sweepers of the earth. Without their efforts, the ground would be knee-deep in dead plants and animals.

### **Lesson 24**

The Termite Story is very similar to the Ant Story. However, there is an even greater contrast to what we firmly believe to be bad but which, in the greater context of Nature, is really highly useful! Stories such as these will hopefully give students an appreciation of the fact that nearly all living things occupy useful places in Nature and mutually benefit all animals and plants in the struggle to survive.

### **Lesson 25**

This makes a nice classroom project that can really build interest for the upcoming Butterfly Hunt! Students can bring the wire hangers and broomsticks or dowelling. The nylon netting or organdy should be purchased at one time.

### **Lesson 26**

This is an activity which works nicely in late Spring or early Autumn. Make certain the area you visit is big enough so all students will have a chance to capture some insects. Include insects other than butterflies in the hunt with a caution about honey bees and wasps. The primary purpose for the Butterfly Hunt is for enjoyment!



**THE  
BUTTERFLY  
CURRICULUM**

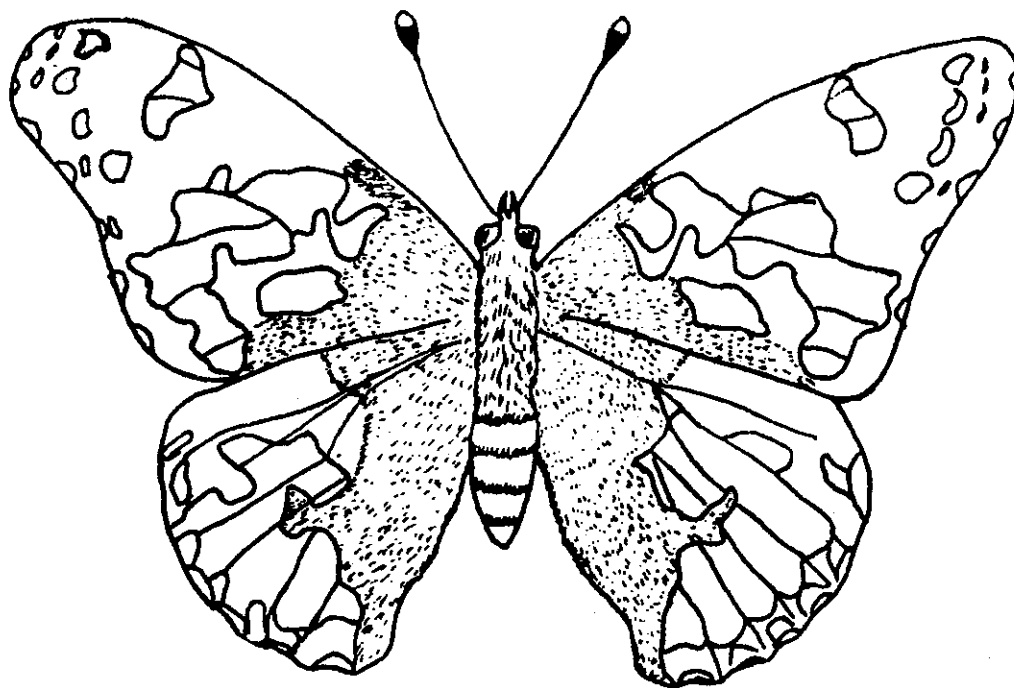

**SUGGESTED ACTIVITIES  
FOR  
GRADES THREE THROUGH SIX  
USING THE  
BUTTERFLY GARDEN® SCHOOL KIT**

## CONTENTS

PREFACE.....	1
SUGGESTED EXTENDED ACTIVITIES.....	2
SUGGESTED BOOKS FOR ADDITIONAL READING.....	3
LEARNING OBJECTIVES AND SKILLS.....	4
TEACHER'S GUIDE - .....	9

### ACTIVITY SHEETS -

LESSON 1 - LET'S RAISE BUTTERFLIES!.....	14
LESSON 2 - HOW LONG DOES IT TAKE FOR A CATERPILLAR TO BECOME A BUTTERFLY?.....	15
LESSON 3 - DOES YOUR CATERPILLAR GROW?.....	16
LESSON 4 - HOW DO INSECTS GROW?.....	17
LESSON 5 - DO CATERPILLARS GROW BEST WHEN IT'S COLD OR WARM?.....	19
LESSON 6 - WHAT IS THE CATERPILLAR'S FAVORITE LEAF?.....	20
LESSON 7 - MAGNIFYING GLASS INVESTIGATIONS: BRISTLES AND LEGS.....	21
LESSON 8 - MAGNIFYING GLASS INVESTIGATIONS: SILK AND SPIRACLES.....	22
LESSON 9 - THE BIG CHANGE!.....	23
LESSON 10 - MAGNIFYING GLASS INVESTIGATIONS: THE CHRYSALIS.....	24
LESSON 11 - WHAT ARE INSECTS?.....	25
LESSON 12 - BUTTERFLY CROSSWORD PUZZLE.....	26
LESSON 13 - GOOD AND BAD INSECTS.....	27
LESSON 14 - THE NEW BUTTERFLY.....	29
LESSON 15 - FIND THE BUTTERFLY PARTS.....	30
LESSON 16 - COLOR YOUR BUTTERFLY.....	31
LESSON 17 - A MOTH OR A BUTTERFLY?.....	32
LESSON 18 - DIFFERENT KINDS OF BUTTERFLIES.....	33
LESSON 19 - HOW DOES A BUTTERFLY TASTE HER FOOD?.....	34
LESSON 20 - WHERE DO BUTTERFLIES LAY THEIR EGGS?.....	35
LESSON 21 - WHAT DOES A BUTTERFLY DO BEFORE LAYING AN EGG?.....	36
LESSON 22 - MAKING A BUTTERFLY NET.....	37
LESSON 23 - A BUTTERFLY HUNT!.....	38
LESSON 24 - THE CATERPILLAR'S STORY.....	39
LESSON 25 - THINGS THAT FLY!.....	40

## PREFACE

The classroom rearing of butterflies provides a strong motivational source of study for developing science skills and understandings. Students want to express themselves as they become excited in witnessing the metamorphosis of the butterflies. This motivating event can be used to develop oral self-expression as well as reading, writing, and even certain math skills.

### THE BUTTERFLY CURRICULUM

Suggested Activities

for

Grades Three through Six

Using

The Butterfly Garden® School Kit

Grateful acknowledgment is expressed to the Los Angeles City Schools, Instructional Planning Division, for some of the ideas and certain manuscript forms used in this curriculum.

## Suggested Extended Activities

### SCIENCE:

1. Grow plants from the seeds of malva, hollyhock, thistle, fiddleneck, or nettle. Later, rear some butterflies on these leaves.
2. Study other flying things. Birds, bats, other insects, flying squirrels (really gliders). There were once even flying reptiles.  
-How are short, stubby wings used? Beaten rapidly, fast fliers.  
-How are large wings used? Beaten slowly, used for gliding.
3. Discuss how a butterfly uses her wings both as lifters and propellers. The veins in the wings are rigid and make the front part of the wing stiff while the back part of the wing bends. During flight the bending back part of the wing forces air backward and forces the butterfly forward.
4. Dissect a flower to find the nectaries. Discover also the parts of the flower that work together to produce seeds (stamens, anthers, pistils, ovary; also petals, sepals, and stem).

### READING AND LANGUAGE:

1. Make a word box and enter new words as you proceed in these activities.
2. How many words can you get out of the word butterfly and caterpillar?
3. Write a story about a butterfly. Encourage the students to give details, i.e.; the kind of butterfly, its color, the time of year, etc. Draw some pictures.



## SUGGESTED BOOKS FOR ADDITIONAL READING

Color Treasury of Butterflies and Moths, Cresent Books, Division of Crown Publishers, Inc., 419 Park Avenue South, New York, NY 10016.

Most pages of this book are devoted to colored pictures of the more common colorful moths and butterflies. There is an excellent introductory section which gives a great deal of behavioral and morphological background on butterflies and an insight into the reasons for such characteristics.

ESS Guide to Butterflies, McGraw-Hill Book Co., Webster Division, 8171 Redwood Highway, Novato, CA 94947.

Many of the suggested activities in this ESS Guide could be used in conjunction with the Butterfly Garden® School Kit.

Hopf, A.L., Butterfly and Moth, New York, G.P. Putnam and Sons, 1969.

This well-illustrated book describes the development of the spicebush swallowtail and the promethea moth in great detail.

Klots, A.E., A Field Guide to the Butterflies, Boston, Houghton-Mifflin Company, 1951.

This field guide is extensively illustrated with colored pictures of the butterflies in North America. Life histories, including distribution and food plants, are given.

Mitchell, R.T., and Zim, H.S., Butterflies and Moths, New York, Golden Press, 1962.

This is an excellent, inexpensive book which can be bought in nearly all book stores. Food plants, colored illustrations of butterflies and moths, as well as many caterpillars and pupae are included.

Sterling, D., Caterpillars, New York, Doubleday & Co., Inc. 1961.

This book contains illustrations and descriptions of the life cycles of the more common butterfly species.

**LEARNING OBJECTIVES & SKILLS  
FOR  
THE BUTTERFLY CURRICULUM  
GRADES THREE THROUGH SIX**

<u>LESSON</u>	<u>SCIENCE OBJECTIVES</u>	<u>READING SKILLS</u>
<p>Lesson 1. Let's Raise Butterflies! <u>Understanding:</u> Living things have needs that must be met.</p>	<p>Pupils develop a suitable environment for their caterpillars and learn procedures that assure the success of their animals. <u>Science Skills include:</u> Careful manipulation of materials and animals.</p>	<p><u>Vocabulary Development:</u> Develop and reinforce vocabulary. Introduction of relevant words to the project. <u>Comprehension Skill:</u> Following written directions.</p>
<p>Lesson 2. How Long Does It Take for a Caterpillar to Become a Butterfly? <u>Understanding:</u> A certain amount of time is needed for growth.</p>	<p>Pupils discover how many days are required for the stages in the butterfly's development. <u>Science Skills include:</u> Observing and recording.</p>	<p><u>Vocabulary Development:</u> Develop and reinforce vocabulary associated with insects. <u>Comprehension Skills:</u> following written directions &amp; interpreting information. <u>Math Skills:</u> Reinforcement of the addition &amp; subtraction functions</p>
<p>Lesson 3. Does Your Caterpillar Grow? <u>Understanding:</u> Changes take place during the growth of the caterpillar.</p>	<p>Pupils observe the growth and development of the larva. <u>Science Skills include:</u> Observing, recording, and illustrating</p>	<p><u>Vocabulary Development:</u> Identifying relevant vocabulary. <u>Comprehension Skills:</u> Following written directions and interpreting information.</p>
<p>Lesson 4. How Do Insects Grow? <u>Understanding:</u> The caterpillar develops into a butterfly through identifiable steps.</p>	<p>Pupils learn the 3 methods by which insects grow and change into adult forms. <u>Science Skills include:</u> Identifying stages and categorizing.</p>	<p><u>Vocabulary Development:</u> Develop new and relevant vocabulary associated with insect terminology.</p>
<p>Lesson 5. Do Caterpillars Grow Best When It's Cold or Warm? <u>Understanding:</u> Cooler temperatures slow or even stop a caterpillar's growth.</p>	<p>Pupils understand that harmony must exist between the caterpillar's growth and its host plant's growth. <u>Science Skills include:</u> Identifying stages and categorizing.</p>	<p><u>Comprehension Skills:</u> Following written directions, interpreting information, and drawing inferences.</p>
<p>Lesson 6. What is the Caterpillar's Favorite Leaf? <u>Understanding:</u> The caterpillar has preferences in food plants.</p>	<p>Pupils isolate and identify plants that the caterpillars prefer. <u>Science Skills include:</u> Manipulating materials, observing, identifying, and recording</p>	<p><u>Comprehension Skills:</u> Following written directions, interpreting information, and drawing conclusions.</p>

**LEARNING OBJECTIVES & SKILLS  
FOR  
THE BUTTERFLY CURRICULUM  
GRADES THREE THROUGH SIX**

<u>LESSON</u>	<u>SCIENCE OBJECTIVES</u>	<u>READING SKILLS</u>
<p>Lesson 7. Magnifying Glass Investigations: <u>Silk and Spiracles.</u> <u>Understanding:</u> The parts of a caterpillar can be found and identified.</p>	<p>Pupils identify setae and legs and learn their characteristics. <u>Science Skills include:</u> Observing, locating, identifying, and illustrating</p>	<p><u>Vocabulary Development:</u> Develop and reinforce vocabulary associated with insect anatomy. <u>Comprehension Skills:</u> Following written directions and drawing inferences.</p>
<p>Lesson 8. Magnifying Glass Investigations: <u>The Chrysalis.</u> <u>Understanding:</u> The parts of a caterpillar can be found and identified.</p>	<p>Pupils identify silk and spiracles and learn their function. <u>Science Skills include:</u> Observing, locating, and identifying.</p>	<p><u>Vocabulary Development:</u> Develop and reinforce vocabulary associated with insect anatomy. <u>Comprehension Skills:</u> Following written directions, interpreting information, and drawing conclusions.</p>
<p>Lesson 9. <u>The Big Change.</u> <u>Understanding:</u> The chrysalis has certain needs which must be met.</p>	<p>Pupils arrange a suitable environment for the chrysalis and butterfly. <u>Science Skills include:</u> Manipulating materials and living chrysalids, observing, identifying, and comparing.</p>	<p><u>Vocabulary Development:</u> Reinforce relevant vocabulary. <u>Comprehension Skills:</u> Following written directions and drawing inferences.</p>
<p>Lesson 10. Magnifying Glass Investigations: <u>The Chrysalis.</u> <u>Understanding:</u> The chrysalis has identifiable structures that are related to the structure of the butterfly.</p>	<p>Pupils identify areas of the chrysalis' body where the structure of the butterfly is forming. <u>Science Skills include:</u> Careful manipulation of living things, observing, locating, identifying, and illustrating.</p>	<p><u>Vocabulary Development:</u> Develop and reinforce vocabulary associated with insect anatomy. <u>Comprehension Skills:</u> Following written directions, interpreting information, and drawing inferences.</p>
<p>Lesson 11. <u>What are Insects?</u> <u>Understanding:</u> Insects have structural characteristics that identify them as a singular animal group.</p>	<p>Pupils learn the characteristics that identify an animal as an insect. Pupils use these characteristics to separate insects from other animals. <u>Science Skills include:</u> Locating, identifying, and comparing.</p>	<p><u>Vocabulary Development:</u> Develop and reinforce vocabulary associated with animals. <u>Comprehension Skills:</u> following written directions, interpreting information, drawing inferences, and forming conclusions.</p>
<p>Lesson 12. <u>Butterfly Crossword Puzzle.</u> <u>Understanding:</u> Recall of word vocabulary associated with butterflies and insects.</p>	<p>Pupils recall and identify words related to butterflies and insects through word association.</p>	<p><u>Vocabulary Development:</u> develop and reinforce vocabulary. <u>Comprehension Skills:</u> Following written directions and interpreting information.</p>

**LEARNING OBJECTIVES & SKILLS  
FOR  
THE BUTTERFLY CURRICULUM  
GRADES THREE THROUGH SIX**

<u>LESSON</u>	<u>SCIENCE OBJECTIVES</u>	<u>READING SKILLS</u>
<p>Lesson 13. Good and Bad Insects <u>Undersanding</u>: Insects are indentified as good or bad according to their habits.</p>	<p>Pupils realize that some insects are good while others are bad and understand the reasons for it. <u>Science Skills include</u>: Manipulating materials, observing, and identifying.</p>	<p><u>Vocabulary Development</u>: Develop and reinforce vocabulary. <u>Comprehension Skills</u>: Interpret information and drawing inferences.</p>
<p>Lesson 14. The New Butterfly. <u>Undersanding</u>: Butterflies need special food.</p>	<p>Pupils prepare food and feeding station for their butterflies <u>Science Skills include</u>: Manipulating materials, observing, and identifying.</p>	<p><u>Vocabulary Development</u>: Develop and reinforce vocabulary. <u>Comprehension Skills</u>: Following written directions and drawing inferences.</p>
<p>Lesson 15. Find the Butterfly Parts. <u>Undersanding</u>: The parts of a butterfly can be found and identified.</p>	<p>Pupils identify and name the butterfly parts. <u>Science Skills include</u>: Locating, identifying and naming.</p>	<p><u>Vocabulary Development</u>: Develop and reinforce vocabulary associated with insects. <u>Comprehension Skills</u>: Following written directions.</p>
<p>Lesson 16. Color Your Butterfly. <u>Undersanding</u>: The butterfly has a unique pattern of coloration on the wings.</p>	<p>Pupils discern the color pattern of the butterfly by copying a likeness in form and color. <u>Science Skills include</u>: Observing and illustrating.</p>	<p><u>Vocabulary Development</u>: Reinforcement of vocabulary. <u>Comprehension Skills</u>: Following written directions and interpreting information.</p>
<p>Lesson 17. A Moth or a Butterfly? <u>Undersanding</u>: Moths and butterflies can be identified according to their physical and behavioral characteristics.</p>	<p>Pupils discern the differences between moths and butterflies by observing their characteristics. <u>Science Skills include</u>: Observing, locating, and comparing.</p>	<p><u>Comprehension Skills</u>: Drawing inferences.</p>
<p>Lesson 18. Different Kinds of Butterflies. <u>Undersanding</u>: Specific color patterns are important for recognition and survival.</p>	<p>Pupils understand the wings of a butterfly are used to attract other butterflies, find food, and escape enemies. <u>Science Skills include</u>: Observing, identifying, and comparing.</p>	<p><u>Vocabulary Development</u>: Develop and reinforce vocabulary <u>Comprehension Skills</u>: Following written directions, interpreting information, and drawing inferences.</p>

**LEARNING OBJECTIVES & SKILLS  
FOR  
THE BUTTERFLY CURRICULUM  
GRADES THREE THROUGH SIX**

<b>LESSON</b>	<b>SCIENCE OBJECTIVES</b>	<b>READING SKILLS</b>
<p>Lesson 19. How Does a Butterfly Taste Her Food? <u>Undersanding:</u> The butterfly's taste buds are located on her feet and the reasonableness of this location.</p>	<p>Pupils locate through a systematic search the areas of the butterfly's body sensitive to taste. <u>Science Skills include:</u> Manipulating living things, observing, locating, identifying, and recording. Deductive reasoning is involved.</p>	<p><u>Vocabulary Development:</u> New words associated with butterfly morphology. <u>Comprehension Skills:</u> Following written directions, drawing inferences, and forming conclusions.</p>
<p>Lesson 20. Where do Butterflies Lay Their Eggs? <u>Undersanding:</u> The butterfly has preferences among plants for egg laying.</p>	<p>Pupils prepare an egg-laying bouquet and by observation, discover butterfly preferences. <u>Science Skills include:</u> Manipulating plants and materials, locating, identifying eggs, and recording.</p>	<p><u>Comprehension Skills:</u> Following written directions and forming conclusions.</p>
<p>Lesson 21. What Does a Butterfly do Before Laying an Egg? <u>Undersanding:</u> A butterfly has an observable behavior pattern when laying eggs.</p>	<p>Pupils observe a well established behavior pattern and understand the reason for it. <u>Science Skills include:</u> Observing, identifying, and recording.</p>	<p><u>Comprehension Skills:</u> Following written directions, drawing inferences, and forming conclusions.</p>
<p>Lesson 22. Making a Butterfly Net. <u>Undersanding:</u> Involves pupils in making a butterfly net.</p>	<p>Pupils make a butterfly net that will be used for the Butterfly Hunt. <u>Science Skills include:</u> Manipulating materials and constructing.</p>	<p><u>Comprehension Skills:</u> Following written directions.</p>
<p>Lesson 23. A Butterfly Hunt! <u>Undersanding:</u> Butterflies can be found in the environment fulfilling their basic needs.</p>	<p>Pupils go on a hunt for butterflies and other insects, learn where to look, and practice care in capturing insects. <u>Science Skills include:</u> Manipulating materials and living things, observing, and locating.</p>	<p><u>Comprehension Skills:</u> Following written directions.</p>
<p>Lesson 24. The Caterpillar's Story. <u>Undersanding:</u> Nature can be beautifully described through poetry.</p>	<p>Pupils understand the beauty of the butterfly's metamorphosis through the medium of poetry.</p>	<p><u>Vocabulary Development:</u> Adding new words through the motivation of poetry. <u>Comprehension Skills:</u> Following written directions, interpreting inferences, enjoyment of poetry, sentence formation, and creative writing.</p>

**LEARNING OBJECTIVES & SKILLS  
FOR  
THE BUTTERFLY CURRICULUM  
GRADES THREE THROUGH SIX**

LESSON	SCIENCE OBJECTIVES	READING SKILLS
<p>Lesson 25. Things that fly.  <u>Undertanding:</u> There are relationships between living and man-made things.</p>	<p>Pupils identify living and man-made flying things and compare their similarities and differences.  <u>Science Skills include:</u> Identifying, comparing and analyzing.</p>	<p><u>Comprehension Skills:</u> Following written directions, drawing inferences, and interpreting information.</p>

## TEACHER'S GUIDE

### LESSON 1 -

Students should be cautioned to handle the caterpillar cups carefully. The nutrient will sometimes dislodge and crush the larvae. Pack the nutrient snugly in the bottom of the cup to prevent this.

The caterpillars can take a fairly wide range of temperatures. Keep the cups out of direct sun and don't let them freeze.

Transfer the chrysalids into the Butterfly Garden box after they form and harden. If the chrysalids have dropped from the lids of the cups, gently pick them up and make the transfer. To give the newly emerged butterflies a good foothold to hang while expanding their wings, a 2" strip of paper toweling can be taped to the sides next to the bottom of the box. The butterflies will not be hungry immediately after emerging. Like a baby chick, they have food stored in their bodies for the first day or two after emergence. If the daytime temperatures are 60 degrees or above, you may release the butterflies. Pick the warmest part of the day and preferably near some flowers.

### LESSON 2 -

Entry dates for the arrival of the caterpillars, their transformation to chrysalids, and finally the butterfly emergence must be entered in the spaces provided. This activity will be completed approximately 17 - 20 days after the arrival of your caterpillars. The students are really interested in knowing how long it takes for a caterpillar to become a butterfly. Both addition and subtraction are involved in computing the answers to these questions.

### LESSON 3 -

At normal room temperatures, growth of the caterpillars will be rather fast. From 7 - 11 days after you receive them, the caterpillars will have finished their growth and will change to the pupal stage (chrysalids). The pupal stage lasts from 7 - 10 days. Butterflies will live from one to three weeks, depending largely on the regularity of their feedings.

### LESSON 4 -

Some insects grow and develop from simple growth, direct development, while most have a more complex complete metamorphosis. These many forms within one insect is a remarkable development which allows the insect to exploit more than one environment in its lifetime. This development makes the insect far more successful in coping with its complete environment.

### LESSON 5 -

1. The cooler the temperature, the slower the caterpillar's growth. Growth stops at approximately 50 degrees F. or below, and at 110 degrees F. or above. Optimum temperatures for most insects are approximately 85 degrees F.
2. Same as above.
3. Most plant growth follows a similar pattern. The caterpillar feeds and grows in harmony with the host plant. The synchrony of development between the plant and the caterpillar is most important in the Spring when a too early growth start for the caterpillar could be disastrous!

## TEACHER'S GUIDE

### LESSON 6 -

The caterpillar may munch on several different kinds of leaves, but once finding a preferred type of leaf will usually quickly consume a large part of it. The success of this experiment depends on how hungry the caterpillar is and how patient you are in letting the caterpillar grow accustomed to its surroundings. If you have given the caterpillar one of its preferred leaves, it will usually complete its life cycle on this type of leaf. This is an interesting experiment since you can observe more typical behavior patterns than can be seen in the small containers on artificial diet.

### LESSON 7 -

1. The setae on the back of the caterpillar are clear or white with small black branch setae. There are 4 or more small setae coming out of each large seta.



The setae are important to help prevent their being swallowed by birds. They also make the body less reflective and therefore not as visible to predators.

2. The 1st 3 pairs of legs (true legs) are black, jointed, and pointed at the tips. The other legs (false legs) are really stumpy extensions of the caterpillar's body.

There are 5 pairs of false legs including the pair on the last segment.

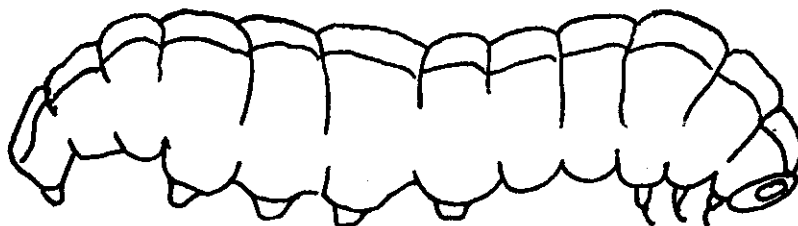

### LESSON 8 -

1. The silk is spun from tiny spinnerets near the mouth. The students can see these pegs with a good magnifier and patience.

2. The tiny circle of hooks (crochets) grasp the silken strands..

3. This hook and silk arrangement gives the caterpillar a firm foothold in the windiest weather.

4. A caterpillar pulls the edges of a leaf around itself to escape the sight of birds and other predators. Its 'leaf home' also protects it from weather elements.

The spiracles are the openings through which oxygen-rich air is breathed into the caterpillar's body and the used air is exhaled. The inhaled air is then carried to and from all parts of the caterpillar's body through small tubes called tracheae.

Oxygen from the air is taken into the lungs and carried by the red corpuscles of our blood through the arteries and capillaries to all parts of the body. Carbon dioxide is carried from the cells of our body by the blood in capillaries and veins to be eventually exhaled from the lungs.

### LESSON 9 -

Self-explanatory.



## TEACHER'S GUIDE

### LESSON 10 -

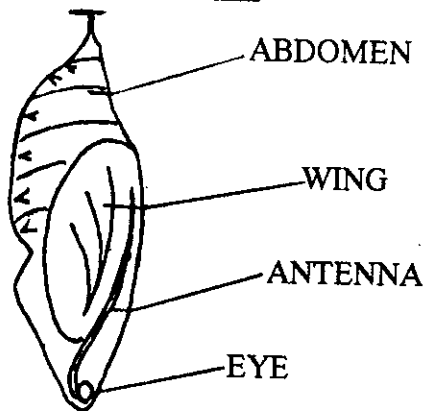

The chrysalis darkens and wing color begins to show through the skin of the chrysalis just before butterfly emergence. This darkening may begin from 12 to 24 hours before emergence.

### LESSON 11 -

This lesson gives the students the knowledge necessary to tell whether an animal is an insect. Spiders, ticks, pill bugs, centipedes, and millipedes are some animals confused with insects. These are closely related arthropods.

### LESSON 12 -

Self-explanatory.

### LESSON 13 -

Like most large animal groups in Nature, there are those species regarded as beneficial and those that are harmful. Our standard for determining this is what direct effect their activities have upon us. In a raw, natural setting in which modern man is not included, many of the so-called bad insects would fit nicely into the scheme of Nature and would actually compliment it. Ask the students what we do about bad insects. Sometimes we have to spray them with poisons to kill them. Sometimes we can spray them with their own diseases to kill them. Poisoned baits are used for some bad insects. Many times good insects, like lady bugs, come and eat the bad insects.

The Ant Story is meant to show that ants are an important and useful part of Nature. Many youngsters grow up with the thought that ants are bad because they sometimes invade our kitchens in search of food. In the great framework of Nature, they are literally the vacuum sweepers of the earth. Without their efforts, the ground would be knee-deep in dead plants.

The Termite Story is very similar to the Ant Story. However, there is an even greater contrast to what we firmly believe to be bad, but which, in the greater context of Nature, is really highly useful! Stories such as these should give students an appreciation of the fact that nearly all living things occupy useful places in Nature and mutually benefit all animals and plants in the struggle to survive.

### LESSON 14 -

The butterfly drinks liquid food only, usually flower nectar. The butterfly feeds by pulling liquids up through the proboscis (feeding tube). She uncoils the proboscis by forcing blood into 2 tiny canals in the proboscis. When the pressure of the blood is released back into the butterfly's body, the tube automatically recoils itself.

## TEACHER'S GUIDE

### LESSON 15 -

Emphasize the usefulness the butterfly parts have in making the butterfly successful in its environment. The wings carry the butterfly quickly over long distances to find food and certain plants on which to lay eggs. The legs are built especially to hang onto flowers or leaves. The taste buds are even on the tips of the second and third pairs of legs! This allows the butterfly to find out whether there is a source of nectar in the flower without uncoiling the long proboscis. The long flexible proboscis can be worked into the smallest opening to reach the flower nectar. The eyes see color very well and with them the butterfly can very successfully find flowers. The eyes see movement very well and can quickly dodge a would be predator.

### LESSON 16 -

Four colors can be easily distinguished on the top of the wings. They are white, orange, brown, and black. The underside of the wings have even more color, but care must be taken in finding them. The colors on the underside are white, brown, tan, black, blue, and purple.

### LESSON 17 -

A butterfly flies in the daytime; a moth flies at night; a moth has feathery antennae; a butterfly has knobbed antennae; a butterfly holds its wings upright; a moth folds its wings flat over its body; a moth has a fat body; a butterfly has a thin body; a butterfly emerges from a chrysalis; a moth emerges from a cocoon; both like pretty flowers; both carry pollen from flower to flower; both have four wings; a moth sometimes eats our from crops; both are beautiful. (Some moths are very lovely).

### LESSON 18 -

There is purpose in the differences between species of butterflies. The primary reason that each butterfly looks the same as other members of its own species and different from any other species is recognition for mating. Wing design and coloration may also serve as camouflage or for frightening would-be enemies. The Buckeye butterfly has large eyespots on the wings which cause birds to confuse them for a larger animal. Some butterfly wings resemble a leaf when they are folded together. Some butterflies are brightly colored (Monarch) and taste bad. A bird attempts to eat the butterfly but once, thereafter, the bright colors are remembered as bad by the bird.

### LESSON 19 -

The taste receptors are located on the tips (tarsi) of the 2nd and 3rd pair of legs, primarily on the 2nd pair of legs. The 1st pair of legs are tucked next to the butterfly's body just in front of the 2nd pair of legs. To be seen, they must be teased out with the tip of a toothpick.

The location of the taste receptors on the 2nd and 3rd pair of legs is excellent since these touch the flower first as the butterfly alights on a flower.

### LESSON 20 -

The Painted lady will lay her eggs on a variety of plants when more suitable hosts such as malva, hollyhock, fiddleneck, thistle, or nettle are not available. If any of the preferred hosts are placed in a bouquet along with other leaves, a great majority of eggs will be laid on the preferred host.

## TEACHER'S GUIDE

### LESSON 21 -

The behavior of an egg-laying butterfly just prior to laying her first egg on a leaf is rather rigid. The sequence of behavior patterns described in the Activity sheet is nearly always followed. Once egg laying begins, (a butterfly may lay 3 to 5 eggs before flying off), the portion of the behavior pattern may be abbreviated since the butterfly has already established the correctness of the host leaf.

This behavior pattern checks and double checks the leaf using four senses to make certain the leaf is a correct one for the caterpillar hatching from the egg.

### LESSON 22 -

This makes a nice classroom project that can really build interest for the upcoming Butterfly Hunt! Students can bring the wire hangers and broomsticks or dowelling. The nylon netting or organdy should be purchased at one time.

### LESSON 23 -

This is an activity that works nicely in late Spring or early Autumn. Make certain the area you visit is big enough so all students will have a chance to capture some insects. Include insects other than butterflies in the hunt with a caution about honey bees and wasps. The primary purpose for the Butterfly Hunt is for enjoyment!

### LESSON 24 -

Self-explanatory.

### LESSON 25 -

Both natural and man-made flying things have in common the use of air to fly. Both usually have wings (except a helicopter). Living flying things use muscles as their source of power. Man-made things use engines to power propellers (this is true for jet planes also as their propellers are inside the pod of the jet engine). The engines force air behind the plane to give it thrust. Gliders use only moving air as their source of power.

NAME \_\_\_\_\_

## LET'S RAISE BUTTERFLIES!

Each Butterfly Garden® School Kit will have at least 30 caterpillars (larvae)



, 30 cups and lids

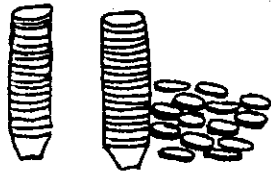

, a brush

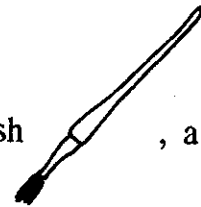

, a spoon



caterpillar food



, a Butterfly Garden® box



for your butterflies

when they hatch, and an instruction booklet



on how to care for your caterpillars and butterflies.

Use the spoon to place a little caterpillar food in each cup. Fill the cup one-third full. Push the food to the bottom of the cup. Carefully pick up the caterpillars with the brush and place one in each cup with the food. Put the lid on the cup. Your caterpillar's cup does not need any holes for air. To remember which caterpillar belongs to you, mark the lid with your name.

Remember these things:

Keep the caterpillar cups upright.

Do not drop the cups.

Do not keep the caterpillars too hot or too cold.

NAME \_\_\_\_\_

HOW LONG DOES IT TAKE  
FOR A CATERPILLAR TO BECOME A BUTTERFLY?

Write the date you received your caterpillars here. \_\_\_\_\_

Write the date your caterpillar changed into a chrysalis (pupa) here. \_\_\_\_\_

Write the date your butterfly emerged from the chrysalis here. \_\_\_\_\_

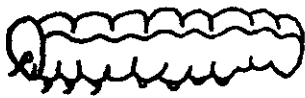

LARVA



CHRYSALIS

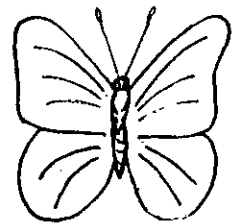

BUTTERFLY

Questions:

1. How many days did it take for the caterpillar to become a chrysalis?

\_\_\_\_\_

2. How many days did it take before the chrysalis became a butterfly?

\_\_\_\_\_

3. How many days did it take for the caterpillar to become a butterfly?

\_\_\_\_\_

4. Did all of the butterflies take the same number of days to become butterflies?

\_\_\_\_\_

5. What was the longest time? \_\_\_\_\_

6. What was the shortest time? \_\_\_\_\_

NAME \_\_\_\_\_

## DOES YOUR CATERPILLAR GROW?

Write the date you received your caterpillars here. \_\_\_\_\_

Watch your caterpillar each day. Does it change? \_\_\_\_\_

A caterpillar sheds its skin 5 times before it becomes a chrysalis. Keep a record of the changes in the caterpillar. Draw some pictures of your caterpillar as it grows. Be sure to write the day number under each picture.

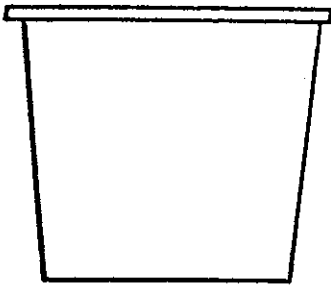

DAY NUMBER \_\_\_\_\_

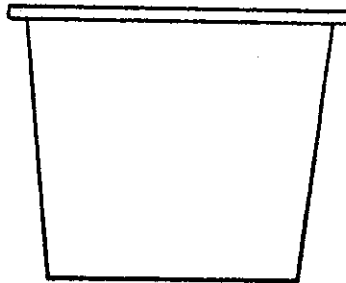

DAY NUMBER \_\_\_\_\_

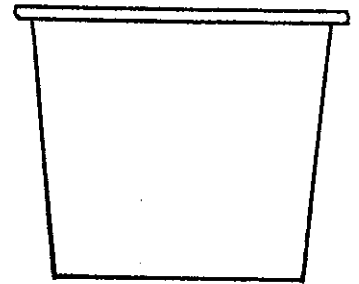

DAY NUMBER \_\_\_\_\_

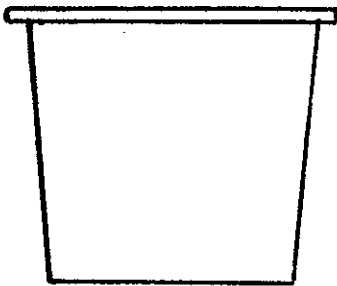

DAY NUMBER \_\_\_\_\_

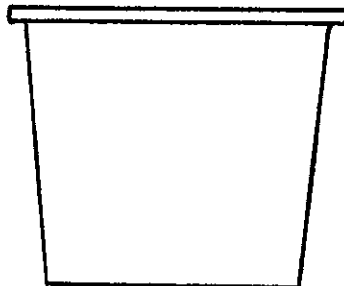

DAY NUMBER \_\_\_\_\_

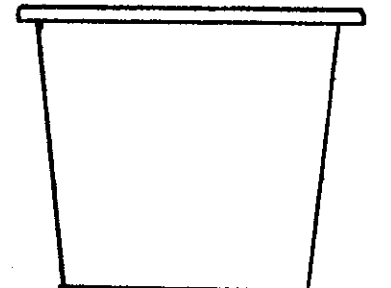

DAY NUMBER \_\_\_\_\_

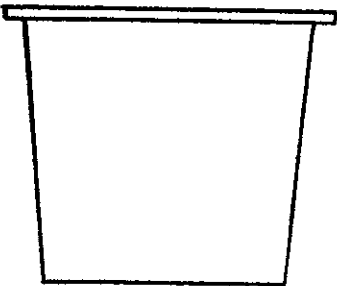

DAY NUMBER \_\_\_\_\_

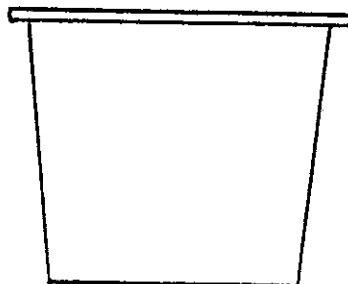

DAY NUMBER \_\_\_\_\_

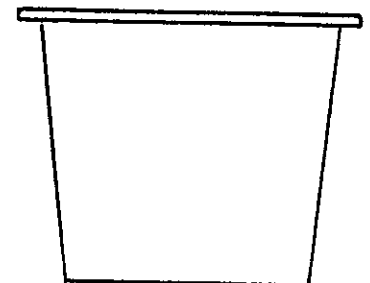

DAY NUMBER \_\_\_\_\_

As the caterpillar grew, could you see more caterpillar parts? \_\_\_\_\_

What parts could you see best? \_\_\_\_\_

NAME \_\_\_\_\_

## HOW DO INSECTS GROW?

The caterpillar becomes a butterfly by going through these steps (stages):

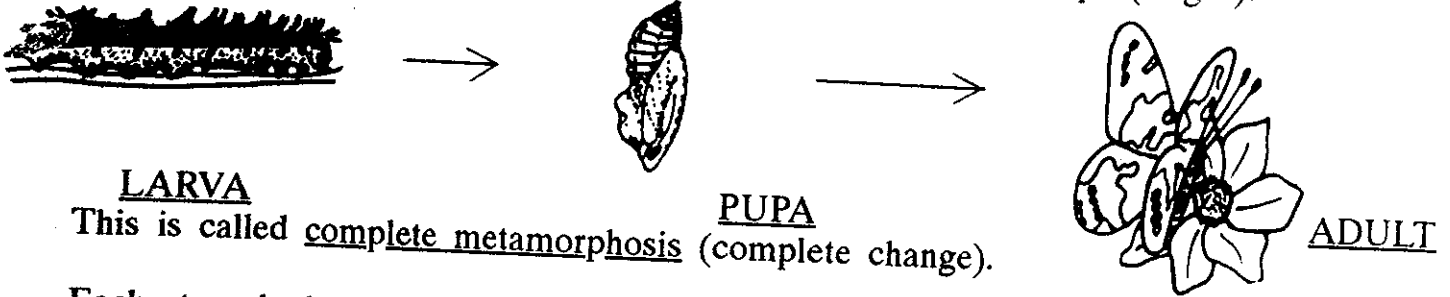

This is called complete metamorphosis (complete change).

Each stage looks much different than the other stages.

Other insects that develop in this way are beetles, flies, bees, and ants.

Some other insects, like grasshoppers, do not change this much as they grow.

A little grasshopper looks much like a big grasshopper.

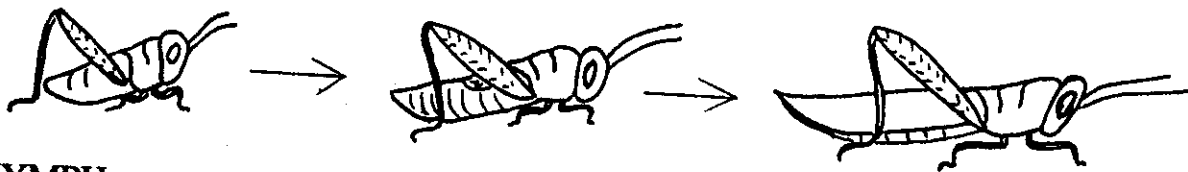

About the only differences between a young grasshopper and a fully grown (adult) grasshopper is the size and the growth of wings.

This is called incomplete metamorphosis (partly changed).

Other insects that develop in this way are crickets, praying mantids, and katydids.

Still other insects are even more simple when they grow.

Here is how the insects are even more simple when they grow.

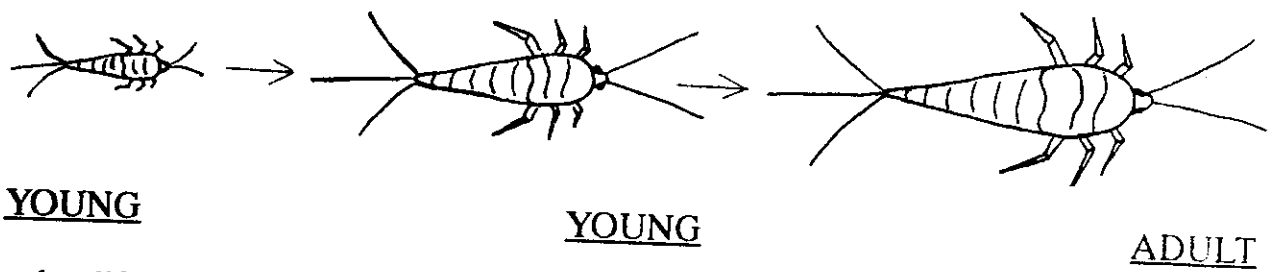

The only difference between the young silverfish and the adult is size.

This is called direct development (grows but does not change).

Very few insects have this simple way of growing.

NAME \_\_\_\_\_

HOW DO INSECTS GROW? (Continued)

How do these insects grow? Complete Metamorphosis? Incomplete Metamorphosis?

Direct Development?

Lady bug beetle \_\_\_\_\_

Painted lady butterfly \_\_\_\_\_

Silverfish \_\_\_\_\_

Housefly \_\_\_\_\_

Wasp \_\_\_\_\_

Red ant \_\_\_\_\_

Honey bee \_\_\_\_\_

Grasshopper \_\_\_\_\_

Green katydid \_\_\_\_\_

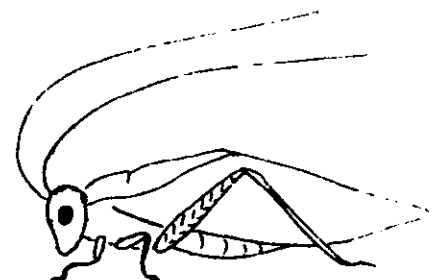
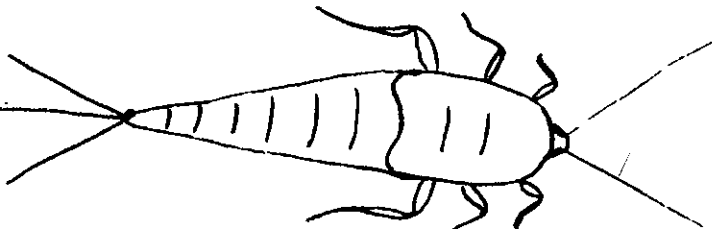
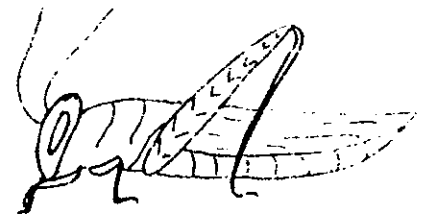
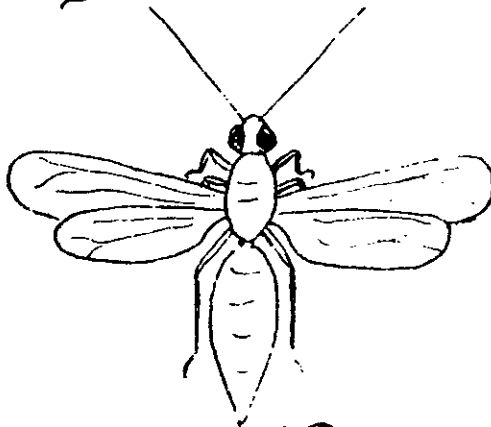
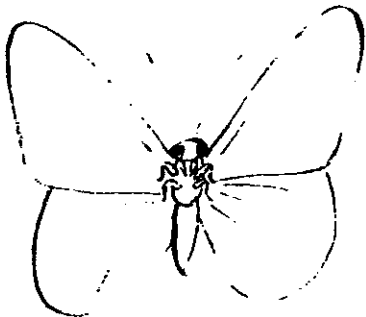
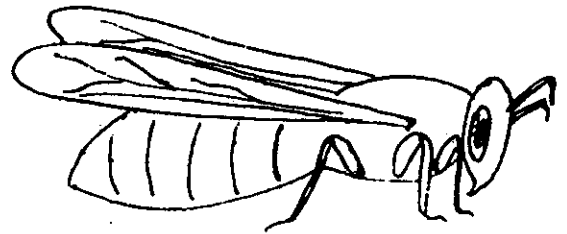
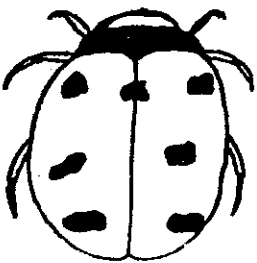



NAME \_\_\_\_\_

## DO CATERPILLARS GROW BEST WHEN IT'S COLD OR WARM?

### Let's try an experiment.

Place 3 cups containing caterpillars and their food on a high shelf in your room.

Next, place 3 other cups in a cooler place in your room, maybe near the floor. After 3 or 4 days, compare the sizes of the 2 sets of caterpillars.

### Questions:

1. Did the caterpillars grow the same in both places? \_\_\_\_\_
2. At which temperature did the caterpillars grow best? \_\_\_\_\_
3. Can you think of any reason why it would be helpful to the caterpillar to grow best at this temperature? \_\_\_\_\_

Did you know that insects are cold-blooded? The body of a cold-blooded animal is just as cold or warm as its environment. Other cold-blooded animals are snakes, lizards, frogs, and snails. Cold-blooded animals eat, grow, and are active only during the warmer part of the year. The plants which caterpillars and other insects use for food also grow only during the warmer part of the year.

Birds and mammals, (dogs, cats, horses, and people) are warm-blooded. Because their bodies stay warm, they can grow, eat, and be active in Winter as well as Summer. Warm-blooded animals must find food in Winter as well as Summer.

Why do many birds fly South in the Winter? \_\_\_\_\_  
\_\_\_\_\_  
\_\_\_\_\_

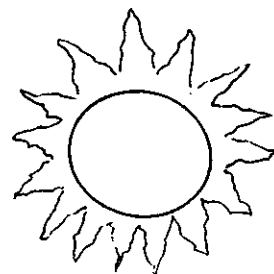

NAME \_\_\_\_\_

WHAT IS THE CATERPILLAR'S FAVORITE LEAF?



Let's try a little experiment to find the caterpillar's favorite leaf.

Gather several kinds of leaves. If it is Wintertime, try some leaves you find in the grocery store. For example: turnip leaves, lettuce, cabbage, spinach, radish tops.

In Nature, you will find Painted lady caterpillars on malva, thistle, nettle, hollyhock, and fiddleneck. Try to include one or more of these kinds of leaves in your experiment.

Make several bouquets of different leaves, trying to include one of the leaves preferred by the caterpillar. Make sure the leaves touch each other so the caterpillar can walk about and pick its favorite leaf. Poke a few small holes in a clear plastic bag and place it over each bouquet to keep the caterpillars from wandering off.

Try the experiment several times.

Write your results in the chart below:

<u>Type of Leaf</u>	<u>Did the caterpillar eat it? Yes or No?</u>
1. _____	_____
2. _____	_____
3. _____	_____
4. _____	_____
5. _____	_____
6. _____	_____

What leaf or leaves did the caterpillar eat? \_\_\_\_\_

\_\_\_\_\_

Try raising one or more caterpillars on bouquets made from its favorite leaf.

NAME \_\_\_\_\_

## MAGNIFYING GLASS INVESTIGATIONS: BRISTLES AND LEGS

With a magnifying glass, look carefully at your caterpillar.

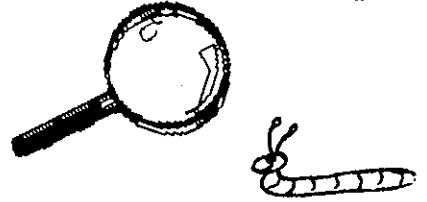

1. Look at the bristles (setae) on the caterpillar (larva).

What color are they? \_\_\_\_\_

Are there little setae coming out of big setae? \_\_\_\_\_

Draw a picture of seta here:

Could the setae help the caterpillar in any way? \_\_\_\_\_

How? \_\_\_\_\_

(Hint) - If you were a bird, how would it feel to swallow a round brush?

2. Look at the legs of your caterpillar. Do the first 3 pair of legs (true legs) look different than the other stumpy legs (false legs)? \_\_\_\_\_

In what way? \_\_\_\_\_

How many pair of false legs can you count? \_\_\_\_\_

Draw the legs in the right places on the caterpillar below:

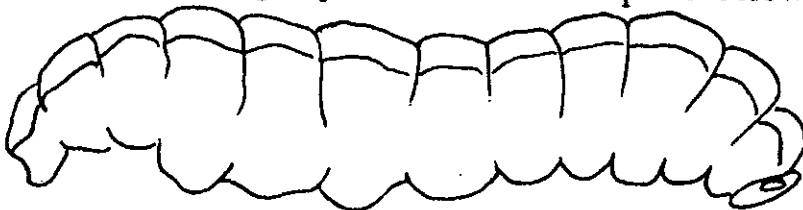

With a strong magnifying glass, look carefully at the end of a false leg. Can you see a circle of tiny hooks? \_\_\_\_\_

These are called crochets!

NAME \_\_\_\_\_

MAGNIFYING GLASS INVESTIGATIONS: SILK AND SPIRACLES



Look at the silken threads your caterpillar has spun in the cup.

1. The caterpillar spins silk from spinnerets (small pegs) near its mouth. Can you find these spinnerets? \_\_\_\_\_
2. How does the caterpillar fasten each false leg to the silken threads?  
Look closely! \_\_\_\_\_
3. How would this be helpful to the caterpillar? \_\_\_\_\_
4. In Nature, the caterpillar also uses the silk to pull the edges of a leaf together around itself. Would this be helpful to the caterpillar? \_\_\_\_\_  
Why? \_\_\_\_\_  
\_\_\_\_\_

Look carefully along the sides of the caterpillar.

The caterpillar's body is made up of segments (like the beads in a necklace).

There is a small, dark hole (spiracle) ringed in white on the sides of each segment.

What is the purpose of the spiracles? Circle the answer you think is right:

- To smell food      To breathe air      To see things      To blow bubbles

How do we get air into our bodies? \_\_\_\_\_

How is the oxygen from the air carried to all parts of our bodies? \_\_\_\_\_  
\_\_\_\_\_

NAME \_\_\_\_\_

## THE BIG CHANGE!

When your caterpillar gets big, watch him carefully.

Your caterpillar will crawl to the top of his cup and hang down.

Like this:

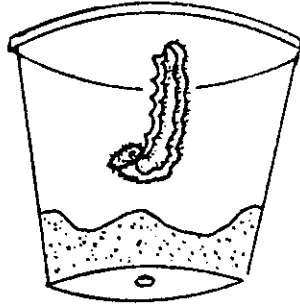

After hanging for about one day, the skin splits along its back. Under the skin is the chrysalis.

The chrysalis soon becomes hard and changes into a pretty golden color.

Take the chrysalis out of the cup and very carefully place it in the box.

This will be a waiting time for you, but the chrysalis is very busy!

The new butterfly comes out of the chrysalis, what parts will it have?

Circle them:

EYES

ANTENNAE

MOUTH

LEGS

WINGS

HEAD

Did the caterpillar have all of these parts? \_\_\_\_\_

Place an 'X' beside each part which the caterpillar had.

NAME \_\_\_\_\_

## MAGNIFYING GLASS INVESTIGATIONS: THE CHRYSALIS

With the magnifying glass, look carefully at your chrysalis.

When your caterpillar has finished growing, it will become a chrysalis.

Look at the chrysalis and answer these questions.

1. Where are the antennae being formed? \_\_\_\_\_
2. The eyes? \_\_\_\_\_
3. The wings? \_\_\_\_\_
4. The abdomen? \_\_\_\_\_

Using your pencil, draw these parts on the drawing of the chrysalis below. When you have finished, color the chrysalis as it looks to you.



5. When the chrysalis is about 7 days old, it will turn dark. What do you suppose this means? \_\_\_\_\_  
\_\_\_\_\_
6. When the chrysalis turns dark, can you see the colors of the wings through the thin shell? \_\_\_\_\_

Did you know that the caterpillars of butterflies form chrysalids, while the caterpillars of moths spin cocoons?

NAME \_\_\_\_\_

## WHAT ARE INSECTS?

Here are those things which an animal must have to be called an insect.

1. Six legs.
2. Three body parts: head, thorax (chest), and abdomen.
3. Four wings (when insect has wings).
4. Two antennae (feelers).
5. Two eyes.

All of the animals below are members of a group called Arthropoda, which means jointed legs.

Circle only the insects in the picture below.



Scarab  
Beetle

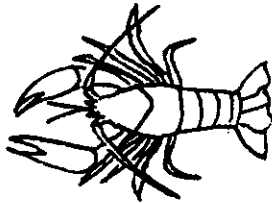

Crayfish

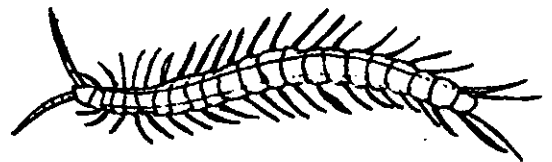

Centipede



Diving Bug

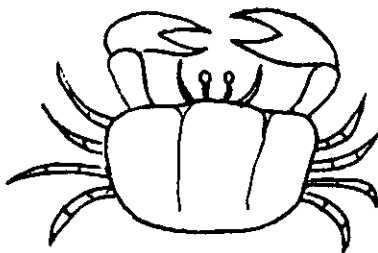

Crab

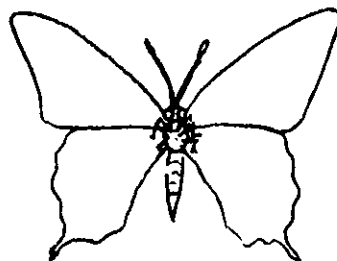

Butterfly

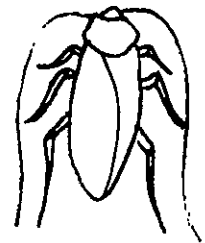

Cockroach

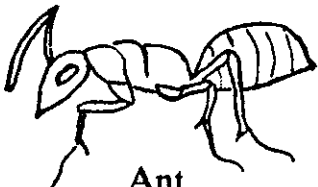

Ant

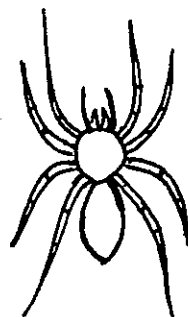

Spider



Tick



Grasshopper



Scorpion



Millipede

NAME \_\_\_\_\_

## BUTTERFLY CROSSWORD PUZZLE

Can you complete this crossword puzzle?

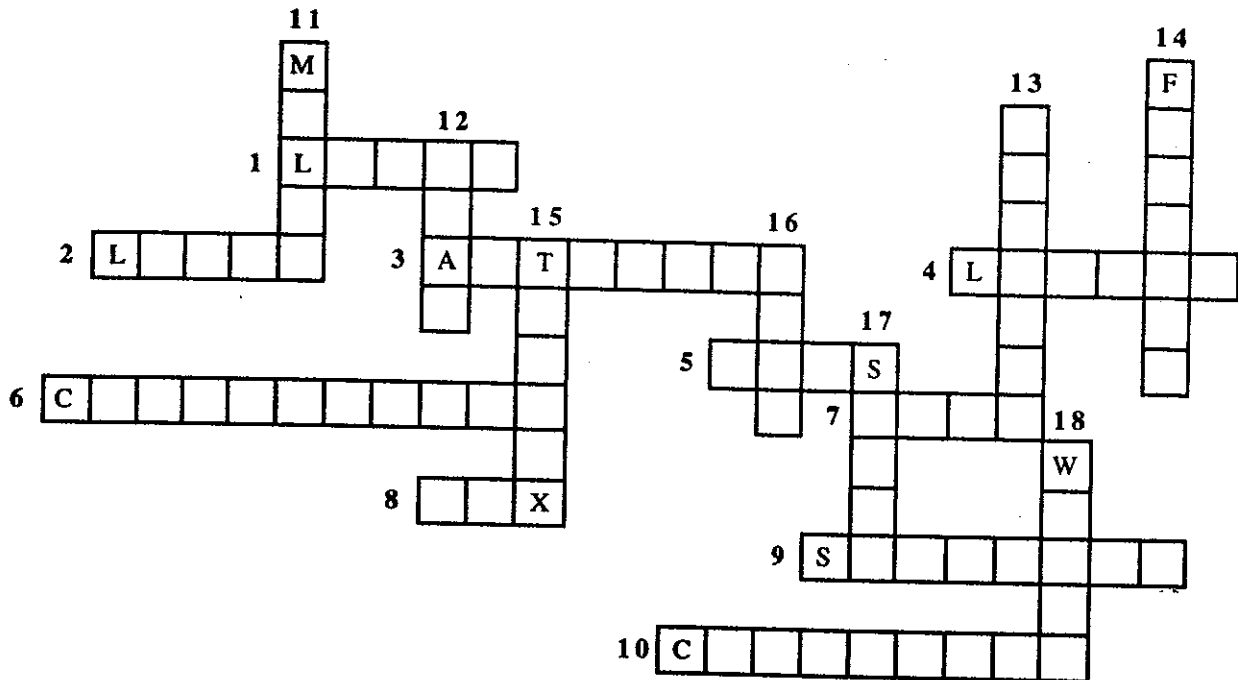

### ACROSS:

1. Butterflies like the \_\_\_\_\_, not the dark.
2. A caterpillar is sometimes called a \_\_\_\_\_.
3. The feelers of a butterfly are called \_\_\_\_\_.
4. The caterpillar eats the \_\_\_\_\_ of a plant.
5. The caterpillar uses its \_\_\_\_\_ to walk about.
6. The butterfly's egg hatches into a \_\_\_\_\_.
7. Caterpillars hatch from \_\_\_\_\_ which the butterfly lays.
8. How many legs does a butterfly have?
9. The caterpillar's body is made up of small \_\_\_\_\_.
10. The caterpillar becomes a \_\_\_\_\_ before it becomes a butterfly.

### DOWN:

11. Painted lady caterpillars like to eat the leaves of this plant.
12. The eyes of a butterfly are found on her \_\_\_\_\_.
13. Butterflies are from a group of animals called \_\_\_\_\_.
14. Butterflies drink the sweet nectar from \_\_\_\_\_.
15. The middle part of the butterfly's body, where the legs and wings are found, is called the \_\_\_\_\_.
16. The butterfly has very good \_\_\_\_\_ to see flowers and leaves.
17. The bristles on a caterpillar are called \_\_\_\_\_.
18. The insects which have these, always have four. What are they?



NAME \_\_\_\_\_

## GOOD AND BAD INSECTS

Some insects we call good, and some we call bad.



Some insects do good things like making honey, pollinating flowers (helps plants make seeds), and eating bad insects.

Other insects do bad things like eating crops the farmers grow, biting us, and sometimes making us sick.



Here are some insects. Tell whether they are good or bad and why.



Good or Bad?

Why?

1. Lady bugs

\_\_\_\_\_

\_\_\_\_\_

2. Ants

\_\_\_\_\_

\_\_\_\_\_

3. Cockroaches

\_\_\_\_\_

\_\_\_\_\_

4. Honey bees

\_\_\_\_\_

\_\_\_\_\_

5. Mosquitoes

\_\_\_\_\_

\_\_\_\_\_

6. Grasshoppers

\_\_\_\_\_

\_\_\_\_\_

7. Termites

\_\_\_\_\_

\_\_\_\_\_

8. Butterflies

\_\_\_\_\_

\_\_\_\_\_

Here are two stories. One story is about ants and the other is about termites.

### THE ANT STORY

Once upon a time, a grasshopper grew old and died. Along came an ant and found the grasshopper. The ant ran back to his friends and told them about the grasshopper. The other ants followed the little ant to where the grasshopper lay. Together, they picked up the grasshopper and carried it to their nest which was not far away. For many days the ants ate the grasshopper and fed their little ants from the grasshopper, too. As they ate the grasshopper, they changed it into nice, rich soil. The very next Spring new plants grows on this new soil. The plants that grew were good food for rabbits, deer, and even grasshoppers. (Questions for ant story on next page).

NAME \_\_\_\_\_

GOOD AND BAD INSECTS (Continued)

ANT STORY QUESTIONS

1. Was the work of the ants good when they ate the grasshopper?
2. Why? \_\_\_\_\_
3. Are ants good when they get into your kitchen? \_\_\_\_\_



THE TERMITE STORY

Are termites good or bad? \_\_\_\_\_ You probably said bad. Read this story and then say whether termites are good or bad.

Once upon a time, a very big, old tree died in the deep forest. The old dead tree stood until the wind from a big storm blew it over. A mother termite found the old tree the next Spring and laid her eggs on it. The eggs hatched and soon the little termites were busy eating the old tree. After a few years, the old tree was almost gone and all that remained was a long mound of soil where the old tree had once lain. The new soil from the old tree was rich and after a few years little trees and other good plants were growing there.

Was the work of ther termites good? \_\_\_\_\_

Why? \_\_\_\_\_

Sometimes termites get into our houses and begin eating the wood like they eat the old dead trees. Termites just cannot tell the difference between the dead wood in our houses and the dead wood in the forest!

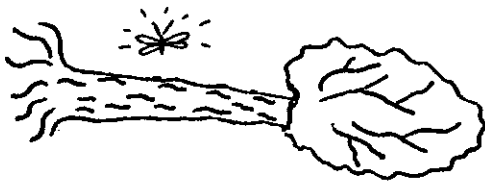

NAME \_\_\_\_\_

## THE NEW BUTTERFLY!

In seven to ten days after the chrysalis forms, your new butterfly should emerge. Just before the butterfly emerges, the chrysalis will turn a dark color and you can see the colors of the wings through the chrysalis. Your butterfly will not be hungry for one day after it emerges. Put the cotton wick in the paper flower in your Butterfly Garden box. Make some sugar water by putting two teaspoons of sugar in a cup of water.

Soak the cotton wick with sugar water, using your eyedropper. For more food, fill an empty jar lid with sugar water. Fold a paper towel and place it in the lid. Change the sugar water every two or three days.

1. How does the butterfly eat? \_\_\_\_\_  
\_\_\_\_\_
2. Does the butterfly have a long tube (proboscis)? \_\_\_\_\_
3. What does the butterfly do with the long tube when she is not drinking? \_\_\_\_\_  
\_\_\_\_\_
4. Can a butterfly eat the same food a caterpillar eats? \_\_\_\_\_
5. Can a caterpillar eat the same food a butterfly eats? \_\_\_\_\_
6. Why or why not? \_\_\_\_\_  
\_\_\_\_\_  
\_\_\_\_\_



NAME \_\_\_\_\_

## FIND THE BUTTERFLY PARTS

Look carefully at your butterfly. Can you find the following parts?

ANTENNAE   EYES   HEAD   LEGS   WINGS   THORAX   ABDOMEN

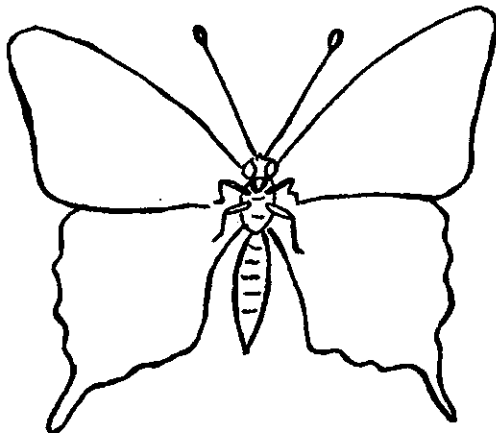

Draw a line from the name to the part on the butterfly.

What do the butterfly parts do?

Antennae \_\_\_\_\_

Eyes \_\_\_\_\_

Legs \_\_\_\_\_

Wings \_\_\_\_\_

Do you see any other parts on your butterfly? \_\_\_\_\_

Describe them if you do. \_\_\_\_\_

\_\_\_\_\_

\_\_\_\_\_

\_\_\_\_\_

NAME \_\_\_\_\_

## COLOR YOUR BUTTERFLY

The picture below is an outline of the Painted lady butterfly.

Look very carefully at the wing colors on your live Painted lady butterfly.

Can you match those colors with crayons to make this paper butterfly look like your live butterfly?

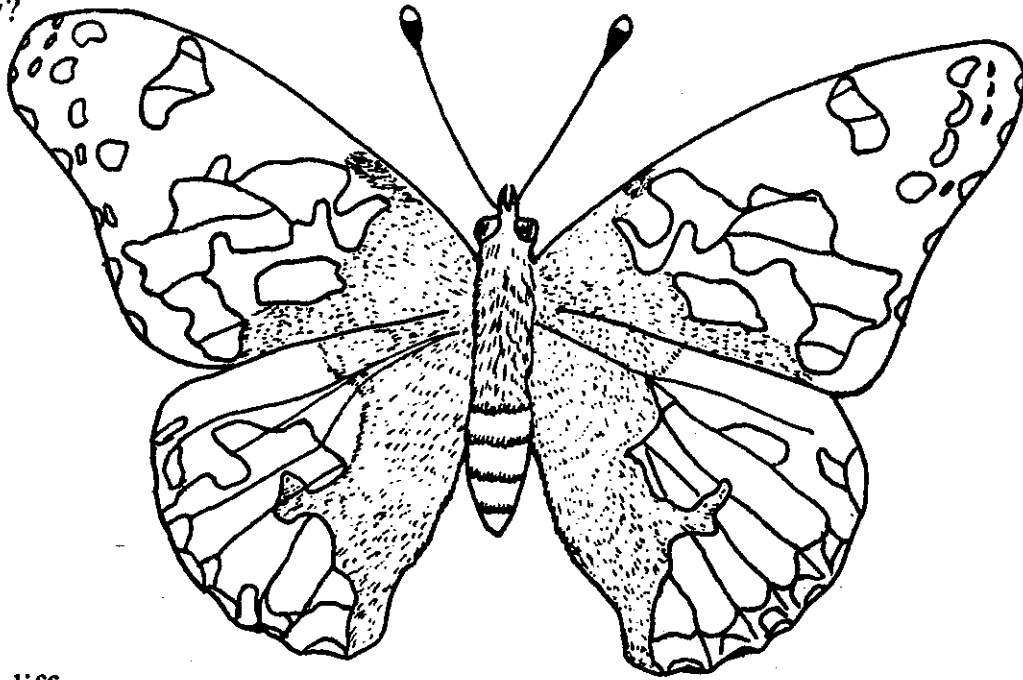

1. How many different colors did you use? \_\_\_\_\_
2. What were the colors you used? \_\_\_\_\_
3. Are these the same colors you would need to color the underside of your butterfly's wings? \_\_\_\_\_
4. What are the colors you would need for the underside of the wings?  
\_\_\_\_\_

NAME \_\_\_\_\_

A MOTH OR A BUTTERFLY?

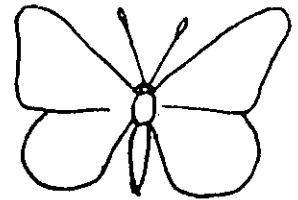
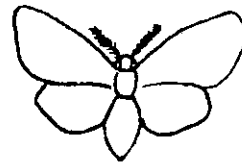

Which is it? A moth, a butterfly, or both?! \_\_\_\_\_

Flies in the daytime \_\_\_\_\_

Flies at night \_\_\_\_\_

Has feathery antennae \_\_\_\_\_

Has knobbed antennae \_\_\_\_\_

Holds its wings upright \_\_\_\_\_

Folds its wings flat over its body \_\_\_\_\_

Has a fat body \_\_\_\_\_

Has a thin body \_\_\_\_\_

Emerges from a chrysalis \_\_\_\_\_

Emerges from a cocoon \_\_\_\_\_

Likes pretty flowers \_\_\_\_\_

Carries pollen from flower to flower \_\_\_\_\_

Has four wings \_\_\_\_\_

Its larvae sometimes eat our farm crops \_\_\_\_\_

Is beautiful to look at \_\_\_\_\_

How are moths and butterflies alike? \_\_\_\_\_

\_\_\_\_\_

How are they different? \_\_\_\_\_

\_\_\_\_\_

NAME \_\_\_\_\_



## DIFFERENT KINDS OF BUTTERFLIES



Check out a book from your library with pictures of butterflies.

Is it easy to see the differences between each kind of butterfly? \_\_\_\_\_

Each kind of butterfly must find its own kind before the mother butterfly can lay her eggs.

How does a butterfly find its own kind of butterfly? \_\_\_\_\_  
\_\_\_\_\_

Butterflies use their wings for other things, too.

Try to find a picture of a butterfly whose wings would make the butterfly resemble something else. A leaf, perhaps, or the bark on a tree.



How would this be helpful to the butterfly? \_\_\_\_\_

Can you find a butterfly with large eyespots on the wings? \_\_\_\_\_

Would these eyespots be helpful to the butterfly? \_\_\_\_\_

In what way? \_\_\_\_\_

A butterfly might use her wings for which of the following:



Circle the right answers:

To help the butterfly find flowers.

To drink the nectar from flowers.

To walk about.

To fool her enemies.

To escape from enemies.

To help her find another butterfly.

Write your favorite kind or kinds of butterflies below.

\_\_\_\_\_  
\_\_\_\_\_

NAME \_\_\_\_\_

## HOW DOES A BUTTERFLY TASTE HER FOOD?

You taste with your tongue. Butterflies do not have tongues; just a mouth formed into a long tube called the proboscis. This is used for sipping nectar from flowers.

Let's find the butterfly's taste buds!

Make sure your butterfly is thirsty. The best way to make certain of this is to keep the butterfly from food for 24 hours.

Do these things:

1. Hold the wings together with your fingers. Hold the butterfly upside down while experimenting.
2. Wet the end of a toothpick with sweetened water (2 teaspoons of sugar in 1 cup of water).
3. Carefully touch each of the parts listed below with the wet toothpick. When the proboscis is uncurled, the butterfly is tasting the sugar water. Remember to give the butterfly time to show that she is tasting. Pull the toothpick away before the butterfly can begin to drink.

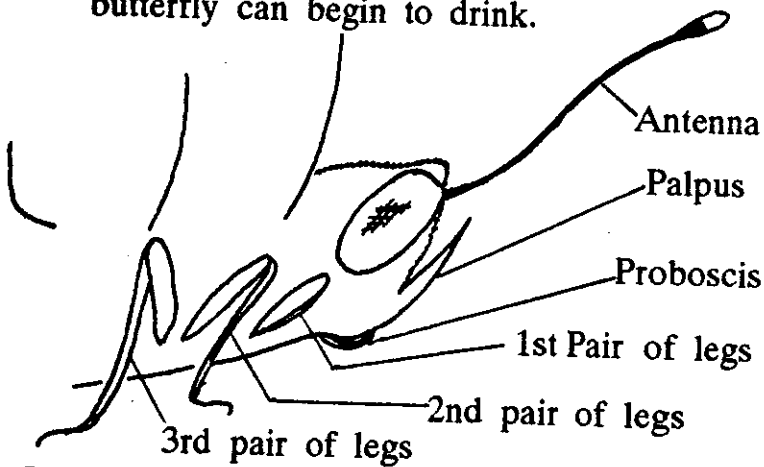

Is this the best place for the taste buds? \_\_\_\_\_

Are these the parts of the butterfly that touch the flower first? \_\_\_\_\_

<u>Location of Taste Buds</u>	<u>Yes or No?</u>
Antenna	
Palpus	
Proboscis	
1st Pair of legs	
2nd Pair of legs (end of leg)	
3rd pair of legs (end of leg)	
Other locations	



NAME \_\_\_\_\_

## WHERE DO BUTTERFLIES LAY THEIR EGGS?

Butterflies like to lay their eggs (oviposit) on just some kinds of plants. When your butterflies are from 3 to 5 days old, they will begin laying eggs on leaves. The Painted lady prefers to lay her eggs on malva, fiddleneck, hollyhock, thistle, and nettle. If she cannot find the leaves of these plants, she sometimes lays her eggs on other kinds of leaves.

1. To find out the kind of leaves she likes, make a bouquet out of 4 or 5 different kinds of leaves. Try to include one leaf from a plant she likes best. Leave the cage a sunny, but not hot, place and watch. Give your butterflies time to lay eggs.

- What leaf has the most eggs? \_\_\_\_\_

- How many eggs are on this leaf? \_\_\_\_\_

- Were any eggs laid on other leaves? \_\_\_\_\_

- Which is the butterflies' favorite leaf? \_\_\_\_\_

2. You may want to raise the caterpillars that hatch from these eggs. If you do, put the leaf in a separate little vase with water and wait for them to hatch. After hatching, pick the little caterpillars up with a small brush and put them on a fresh small bouquet made from the same kind of leaves. As the caterpillars eat and grow, change the bouquet when it gets old or the larvae have eaten it. Wash the leaves under a faucet and blot them dry before placing your caterpillars on them.

- Did your caterpillars grow and finally become butterflies? \_\_\_\_\_

- Use the back side of this sheet to write some interesting things that happened in your experiment.



NAME \_\_\_\_\_

## WHAT DOES A BUTTERFLY DO BEFORE LAYING AN EGG?

An egg-laying butterfly must be sure she lays her eggs (oviposits) on the right kind of leaf. The plants on which she lays her eggs are just the right kind of food for the caterpillars hatching from the eggs.

To make certain she finds the right kind of plant, the mother butterfly must:

1. See the right kind of leaf; (the color must be right).
2. After landing on the leaf, she tastes it with her feet.
3. Next, she smells the leaf with her antennae.
4. Next, she brushes the leaf with her brush-like first pair of legs (prolegs) to be sure the leaf feels right.

Sit by a cage where a butterfly is laying eggs on a leaf and see if all of these things really happen.

Do these things happen? \_\_\_\_\_

Which is used first, the antennae or first pair of legs? \_\_\_\_\_

Once the butterfly begins laying eggs, does she use her antennae and first pair of legs each time before laying an egg? \_\_\_\_\_

Why or why not? \_\_\_\_\_

Does using all four senses make certain that the eggs are placed on just the right plant? \_\_\_\_\_ Discuss your findings with others.

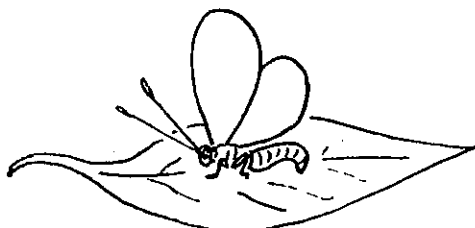

NAME \_\_\_\_\_

## MAKING A BUTTERFLY NET

### You will need:

1 piece of nylon netting or organdy, 2 feet by 3 feet.

1 coat hanger

1 broomstick or 3/4 inch dowelling, three or four feet long.

Step 1. Fold netting in half.

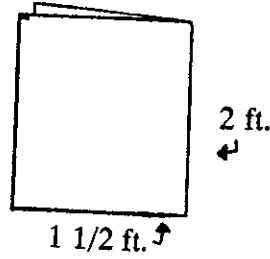

Step 2. Cut folded netting.

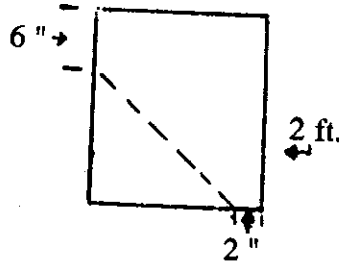

Step 3. Unfold and make three inch hem at top.

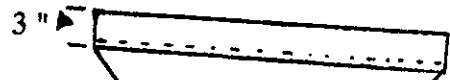

Step 4. Fold again and sew together as shown.

leave open

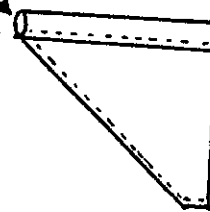

Step 5. Straighten a hanger, bend in a circle, and thread through hem.

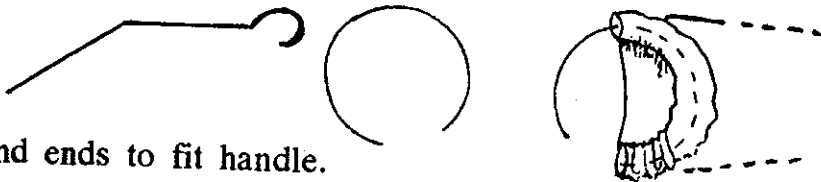

Step 6. Bend ends to fit handle.

Step 7. Tape wire to handle.

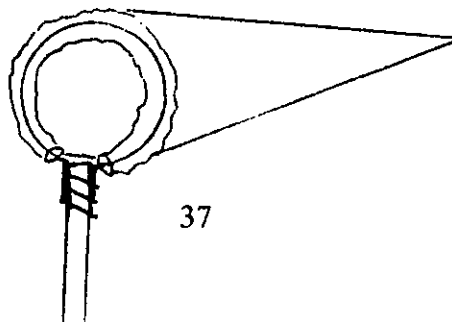

NAME \_\_\_\_\_

## A BUTTERFLY HUNT

You will need:

1. A butterfly net.

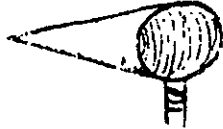

2. Small paper envelopes or a Butterfly Garden box.

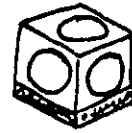

3. Sharp eyes and quiet voices!



The Best Time to go hunting butterflies is when the weather is sunny and warm.

The Best Place to hunt for butterflies is around flowers. Butterflies sip the sweet nectar from the flowers.

The Best Way to Catch a butterfly is to walk slowly and quietly to the butterfly and quickly drop the hoop of the net over the butterfly and the flower she is on.

Next, hold the tip of the net up and gently shake the net.

The butterfly will usually fly to the top of the net.



Hold the butterfly through the netting with one hand and then with your other hand reach into the net and grasp the butterfly. Hold the wings together and pull the butterfly from the net and place her in a paper envelope or in the Butterfly Garden box. Bring a few flowers and leaves from the plant she was on. Place these in a small vase with water when you get back to your room and put them into the butterfly cage.



Try to catch some other insects, too. Leave the wasps and bees alone, though!

How many kinds did you find? \_\_\_\_\_

Do you know the names of any of the butterflies and insects you captured? \_\_\_\_\_

Using an insect book from your library, write the names of those you captured on the back of this sheet.

NAME \_\_\_\_\_

## THE CATERPILLAR'S STORY

Do you like poetry? Most students like good poems.

Read this very nice poem.

### THE CATERPILLAR'S STORY

Caterpillar on the ground

Wrapping a leaf all around.

Enemies without; you're within

Eating and waiting to begin again

Spinning fast now, turning around

Hang head down.

Waiting,  re

Beautiful and golden the home you wear.

Now look! Look! Up in the sky

A beautiful, soaring butterfly!

- *Chris R. Lids*

1. Put the poem into your own words. Use the space next to the poem.
2. Did you like this poem? \_\_\_\_\_
3. Do the lines of the poem rhyme? \_\_\_\_\_
4. Do all poems rhyme? \_\_\_\_\_
5. Use the other side of this page to make up a poem of your own about butterflies!

# LITERATURE/METAMORPHOSIS LESSON

LISTENING      SPEAKING      READING      WRITING

**The Very Hungry Caterpillar**

**Author: Eric Carle**

**Illustrator: Eric Carle**

**Look...a Butterfly**

**Author: David Butts**

**Illustrator: Eulala Conner**

**Day 1 - Listening**

Read the two stories to the students. Review the letters/sounds "B" and "C."

**Day 2 - Speaking**

Re-read the stories focusing on the predictable vocabulary.  
Discuss the vocabulary.

**Day 3 - Speaking**

Re-read the stories. Ask students to discuss each page. Ask comprehension questions.

**Day 4 - Reading**

Have students read the story to you. Discuss differences/similarities; reality/fantasy.

**Day 5 - Writing**

Make two class books - one emphasizing fantasy, the second, reality.  
Fantasy Format: Use bulletin board leaf pattern or the

caterpillar pattern for a shape book;

**Reality Format:** Make a pop-up book. Ask students to make the life cycle of butterfly by cutting/pasting pictures or illustrating the stages of development (Stages 1,2,3 on cover; stage 4 inside).

**WORD SKILLS:** phonics, context clues, rhyming

**VOCABULARY:** Days of the Week;

Number Words

cocoon	chrysalis
shell	butterfly
leaf	life cycle
egg	caterpillar
pupa	

### **SUGGESTED CRITICAL THINKING/COMPREHENSION QUESTIONS**

1. Name something the caterpillar ate. Could it really have eaten this or was it make-believe? Tell why or why not.
2. Describe the stages of the life cycle of the butterfly.
3. Would you rather be a caterpillar or a butterfly? Why?
4. Describe how you think the caterpillar feels inside the chrysalis.
5. Which of the two stories could have really happened? Why?

### **SUGGESTED GROUP/INDEPENDENT ACTIVITIES**

Find five pictures that begin with the sound "C" and five that begin with the sound of letter "B" in magazines, newspapers, cut out pictures, and glue/paste on manila paper.

- Listening Station - Record the two stories and have students listen to them.
- Prepare small pieces of fruits highlighted in The Very Hungry Caterpillar.
  1. Give each student one piece of the same fruit to taste (i.e. all children get a piece of apple). Ask each student what the fruit tasted like (descriptive adjectives). Write student responses on chart paper. Repeat the process with all the fruits in the book, creating a descriptive adjective word bank.
  2. Prepare a bar graph by asking each child if they liked/disliked each fruit. Ask students to color the grid that represents his/her response. Discuss the final results with the class. Ask students to duplicate the completed graph on his/her own paper.

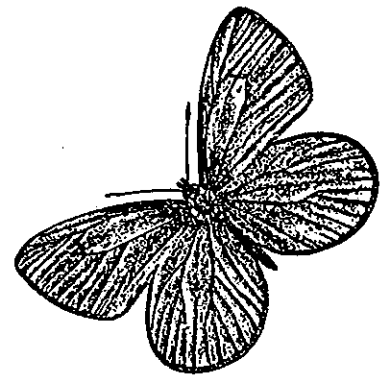
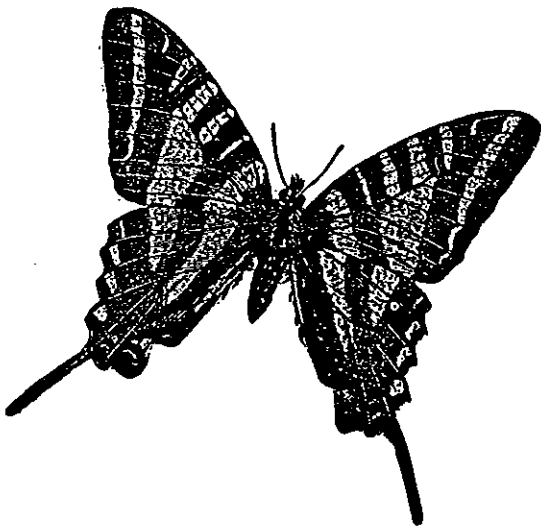



## **ACROSS THE CURRICULUM MISCELLANEOUS ACTIVITIES\***

1. Pour salt/sand onto a small tray deep enough for the letters to be written legibly. Ask students to trace the letters "Bb" and "Cc" with the pointer finger;
- \*2. Butterfly number concept matching activity;
- \*3. Caterpillar sequencing cards;
- \*4. Butterfly and caterpillar estimation (Materials: 2 jars, small butterfly pretzels, gummi-worms);
- \*5. Using caterpillar measuring paper, estimate how many caterpillars long each item on the page is. Do this prior to actually measuring the objects.
- \*6. Caterpillar measuring activity;
- \*7. Ordered pair: A Royal Traveler;
8. Walk around your school/neighborhood on a field trip searching for butterflies/caterpillars;
- \*9. The Eric Carle Art Kit:  
Sun - Cover with yellow corn/rice/yellow yarn/flat spaghetti.  
Paint yellow. Apply stand-up tissue paper.  
  
Caterpillar - Brown rice/pinto beans/stand-up tissue. Use thin spaghetti for legs; paint black. Use brown glue-wash and cover with thin layer of cotton to look "fuzzy."  
  
Butterfly - Colored rice/stand-up tissue paper/ironed-on crayons.
- \*10. Music - Sing "See the Caterpillar;"



# How to use your Butterfly Garden® School Kit

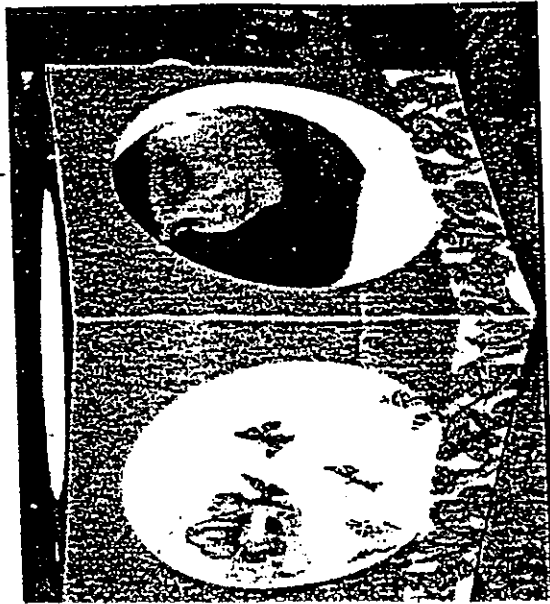

# Butterfly Garden® School Kit



Featuring  
The Painted Lady Butterfly

- Using the brush, gently place one larva in each of the vials.
- Cap the vials quickly to prevent the larvae from escaping.

Keep the vials upright and out of direct sunlight. Do not place any holes in the lid. It is not tight fitting. There will be enough air for them.

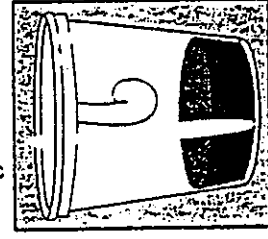

Once the chrysalides have formed, place the lids with the attached chrysalides in your garden box. If the chrysalides have fallen from the lid, gently pick them up with forceps and place them in the box. Keep the box out of direct sunlight.

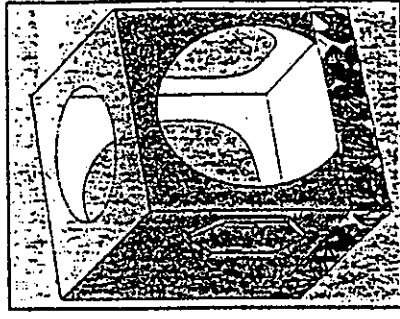

When the butterflies emerge, feed them daily with a solution of two teaspoons sugar to 1 cup of water. The entire process takes approximately three weeks. After two or three days of observing, release your butterflies into the environment during the warmest part of the day.

Released butterflies compete very well in the natural environment and they can often be seen for several days in the vicinity of release.

### Did you know...

- That a butterfly tastes with its feet?
- It breathes through its abdomen?
- A butterfly may travel 1,000 miles?
- A butterfly bats 10,000 eyes?
- It may lay 500 eggs in its lifetime?
- It uses its colored wings to attract other butterflies?



## How to use your Butterfly Garden® School Kit



### IMPORTANT!

Always keep your butterfly vials upright and out of direct sunlight.

To keep the nutrient clean, keep the lid on the vials. Wash hands carefully before working with the larvae. It is very important to keep everything clean!

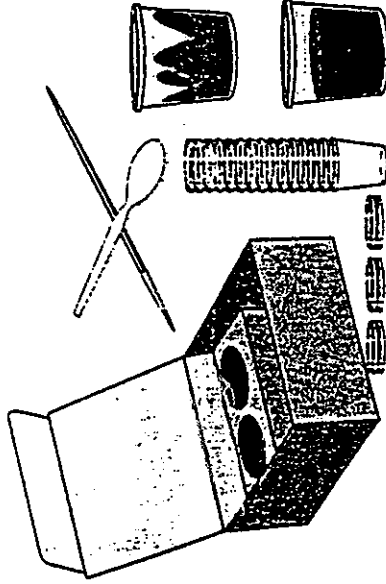

Your Butterfly Garden® School Kit contains a flight cage, 30 butterfly larvae, eight ounces of nutrient, 30 vials with lids, a spoon and a brush.

### WASH YOUR HANDS!

- Using the enclosed spoon, place approximately 1/4 inch of nutrient in each vial.
- Placing the nutrient firmly in the bottom of each vial will prevent the nutrient from dislodging and crushing the larvae. Be as clean as possible in your technique.

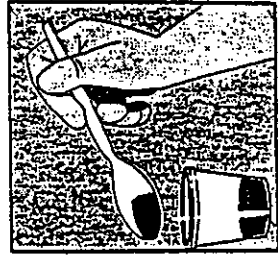

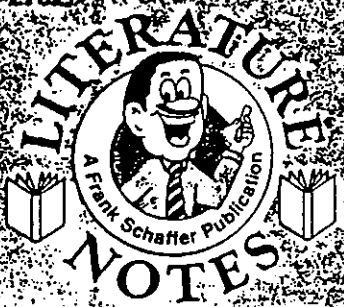

A product of Frank Schaffer Publications, Inc.  
Not produced in association with any other publisher.

# The Very Hungry Caterpillar

## SYNOPSIS

*The Very Hungry Caterpillar*, written and illustrated by Eric Carle (Philomel, 1969), is a wonderful story about a very tiny and very hungry caterpillar. One Sunday morning a caterpillar hatches from an egg. On Monday he eats through one apple. On Tuesday he eats through two pears. As the week goes by, the caterpillar eats more and grows bigger, until finally he spins a cocoon. He later emerges as a beautiful butterfly.

## THEMES

*The Very Hungry Caterpillar*, a tale of a caterpillar's life cycle, could easily be incorporated into an insect unit or a spring unit. It would also fit nicely into a health unit about different kinds of food, as the caterpillar in the story feasts on fruits and then on some less healthful foods.

## BULLETIN BOARD

Involve your students in creating this eye-catching display during your class study of *The Very Hungry Caterpillar*. See inside for a pattern and directions.

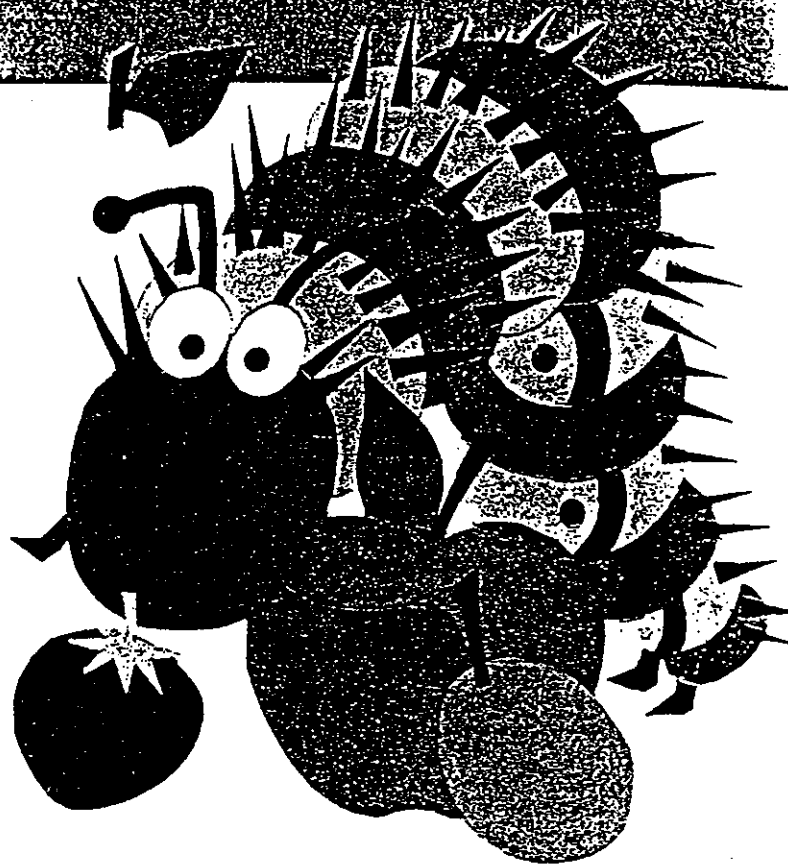

## The Very Hungry Caterpillar

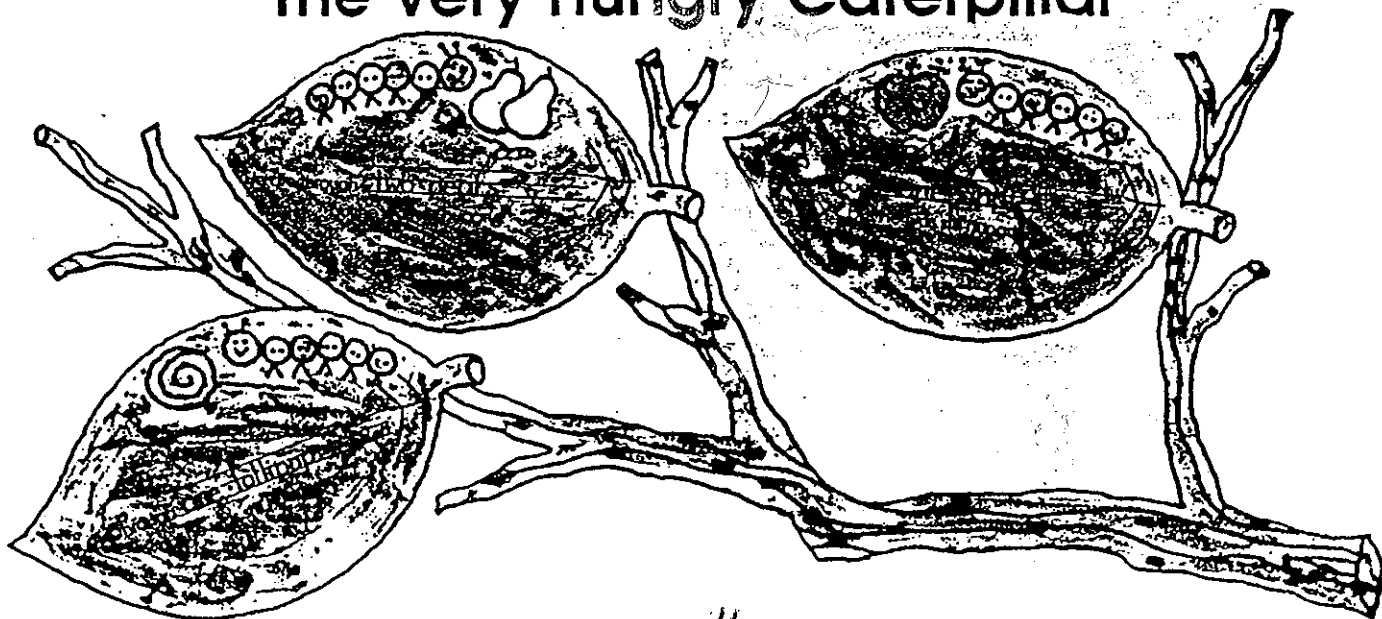

# Language Arts Activities

## Language Development Word Cards

Involve students in this language activity after they are familiar with the story. Make word cards for the days of the week, the number words one through five, and the first five fruits the caterpillar eats through.

With your class, review what the caterpillar ate each day of the week. For example, ask "What was the first thing the caterpillar ate through? Right, it was an apple. How many apples did he eat? What day of the week was it? Yes, that's right. On Monday, he ate through one apple." Place the word cards for *Monday*, *one* and *apple* in a pocket chart as they are mentioned.

Continue retelling the story using the other word cards. When discussing Saturday's meal and Sunday's meal, simply place the word cards for the days in the pocket chart.

Monday	one	apple
Tuesday	two	pears
Wednesday	three	plums
Thursday	four	strawberries
Friday	five	oranges

## Pictorial Story Map

Focus on the cycle of events in *The Very Hungry Caterpillar* by creating with your students a story map. Ask them how the story began. When children mention the egg, draw a small egg on the chalkboard or on a piece of chart paper and label it. Have the children describe the rest of the events in the story as you continue drawing the story map.

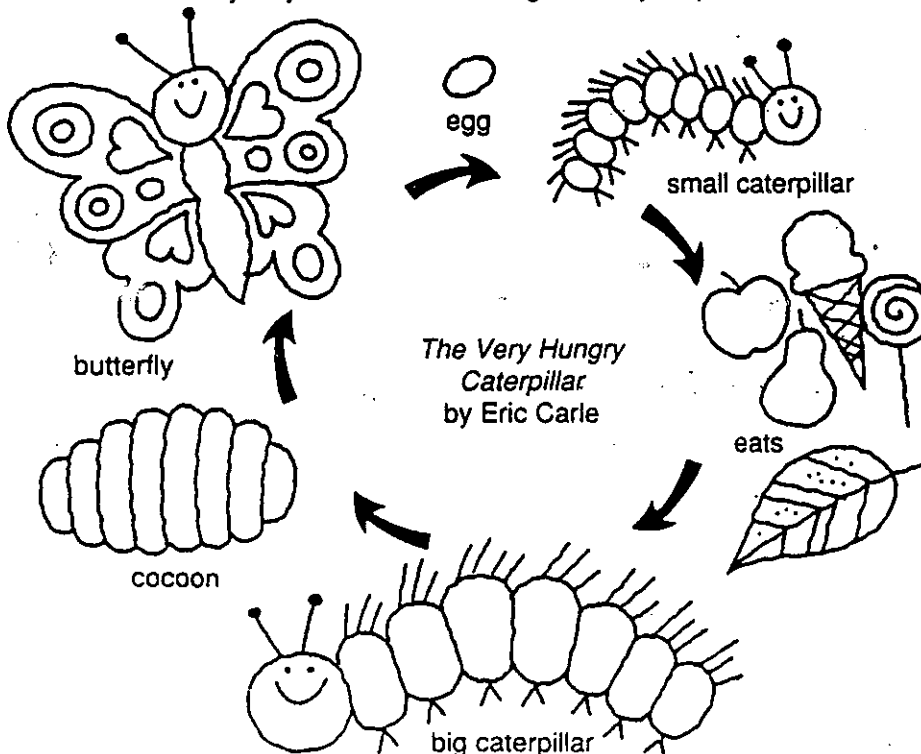

## About the Author— Eric Carle

Eric Carle, author and illustrator of many award-winning children's books, was born in New York in 1929, but he spent much of his childhood in Germany. One of the few books he owned as a child was a Mickey Mouse book. He remembers colorful paints, large sheets of paper, and big paintbrushes in kindergarten in the United States. Carle has always enjoyed making pictures. It wasn't until he was over 40 that he began illustrating for children. His books are well-known in Germany and the United States. *The Very Hungry Caterpillar* has been translated into 12 different languages and is enjoyed in homes and classrooms around the world.

# Critical Thinking Activities

## Prereading

Before reading the story, show pictures and initiate discussion about the four stages of a caterpillar's life cycle (egg, caterpillar, cocoon, butterfly). Encourage discussion by asking questions such as "Where does a caterpillar come from?" Invite your students to share experiences they have had with caterpillars or butterflies.

## Reading

Read the story to your class once without interruption. Then read it again, asking these questions.

- Where did the little egg come from?
- Why did it hatch on a sunny day instead of at night?
- Could this story have really happened or is it make-believe? How do you know?
- Tell what the caterpillar does that caterpillars really do. Then tell what he does that caterpillars do not really do.
- List words in this story that tell all the things the caterpillar did.
- Tell about a time you got a stomachache from eating too much.
- What do you think a caterpillar does when he is inside the cocoon?
- How does a caterpillar make a cocoon?
- Would you rather be a caterpillar or a butterfly? Tell why.

## Postreading

Encourage your students to retell the story using a very hungry caterpillar sock puppet. Make one by using a permanent marker to draw a face on the toe of a green sock. Have your students take turns using the puppet to retell the story from the caterpillar's point of view. For example, a student may say, "One sunny day I popped out of an egg. I was so hungry that I ate through one apple, two pears, three plums . . . On Saturday I had a bad stomachache!" Place the puppet and the book at a classroom learning center so each child can have a turn retelling the story.

Expose your students to other books written and illustrated by Eric Carle.

*The Grouchy Ladybug* (Crowell, 1977)

*The Mixed-up Chameleon* (Crowell, 1984)

*The Tiny Seed* (Picture Book Studio, 1987)

*The Very Busy Spider* (Philomel, 1985)

Explain that Carle used the collage technique to create his illustrations. He prepared special paper and then cut it and glued it to sheets of paper to make the pictures. Let your students imitate this technique. Have them make a sun like the one in the story. First, have students paint yellow brush strokes on orange construction paper. After the paint dries, have students cut a large circle and many small strips from the paper. Then have them glue these pieces to another sheet of paper to make a sun.

## Art Idea

### Fruit Printing

Gather the five fruits that were mentioned at the beginning of the story (apple, pear, plum, strawberry, and orange\*). If some of these fruits aren't available in your area, provide substitutions. Cut the fruits in half and place them at an art center next to shallow dishes of brightly colored paints and large sheets of paper. Allow children to dip the fruit halves into the different colors of paint and print them onto the paper. Display these beautiful wall hangings in your classroom.

\*Orange halves make a better print if the juice is squeezed out beforehand.

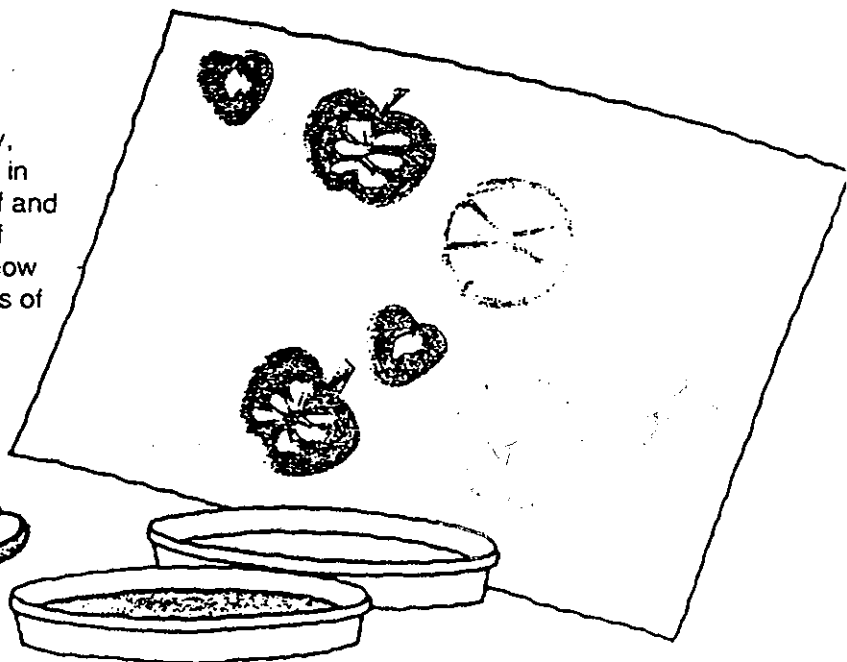
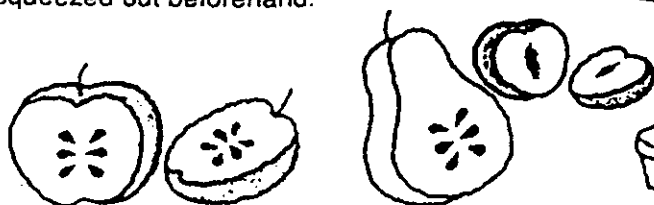

# Across-the-Curriculum Activities

## SOCIAL STUDIES

### People Change

Review the changes a caterpillar goes through during its life cycle. Encourage discussion about how people change over their lifetime. Cut out magazine pictures that show people in various stages of life and show them to your students. Allow your students to tell about their experiences with babies, siblings, grandparents, and so on. Then give each student a large sheet of drawing paper that has been folded twice so that there are four sections. Instruct students to draw themselves in four different stages of their lives. For example, as a baby, at five years, twenty years, and eighty years. Encourage the children to tell each other about their drawings when they are completed.

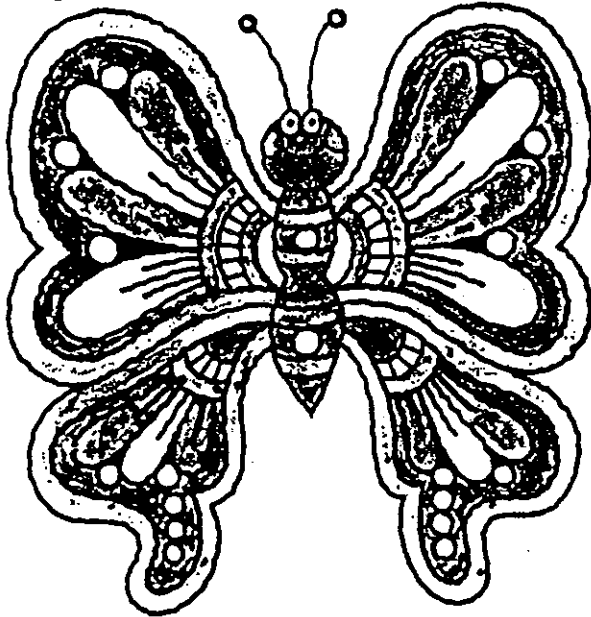

## WRITING

### Caterpillar Shape Books

Encourage children to write their own versions of *The Very Hungry Caterpillar*. For each child make one copy of the book cover pattern found inside this folder. Cut out the covers. Then using one of the copies as a pattern, trace five to six shape pages for each student. Staple a set of pages to each cover. Have children illustrate their story and tell it to you as you print their words. Or you may want your students to write their own words. Have students read their completed books to each other before they take them home to share with their families.

## SCIENCE

### Caterpillar Life Cycle Cards

Use the book *The Very Hungry Caterpillar* to review with your students the four stages of a caterpillar's life (egg, caterpillar, cocoon, butterfly). Provide each student with four 3" x 5" index cards, one button, a cotton ball, and a small piece of brown construction paper. Have your children follow the directions below to make cards showing the stages of a caterpillar's life in sequence.

First card—Draw and color a leaf. Glue the button on the leaf to represent an egg.

Second card—Draw and color some grass. Stretch the cotton ball. Glue it on the grass to represent a caterpillar.

Third card—Draw and color a branch. Cut an oval shape from the brown construction paper. Glue it hanging from the branch to represent a cocoon.

Fourth card—Use water-based markers to draw a butterfly.

Encourage students to take the sequence cards home and share with their families what they have learned.

## LANGUAGE ARTS

### Touch and Taste Chart

Prepare five different kinds of fruit for your students to touch and taste. Cut the fruit into small pieces and give each child a small paper plate with a piece of each kind of fruit on it. Make a simple chart by dividing a large piece of paper into five columns and drawing one of the kinds of fruit at the top of each column. Then have your students taste one kind of fruit and use adjectives to describe it. Write their responses in the corresponding column. Add to the chart as each kind of fruit is tasted and discussed by the students.

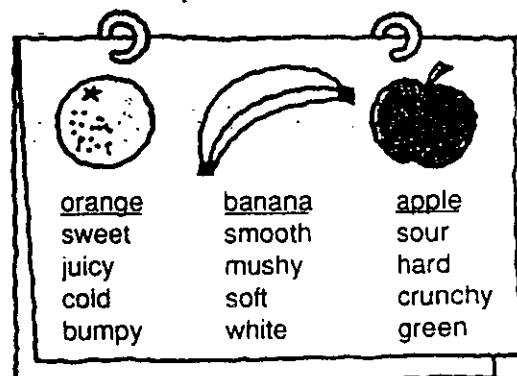

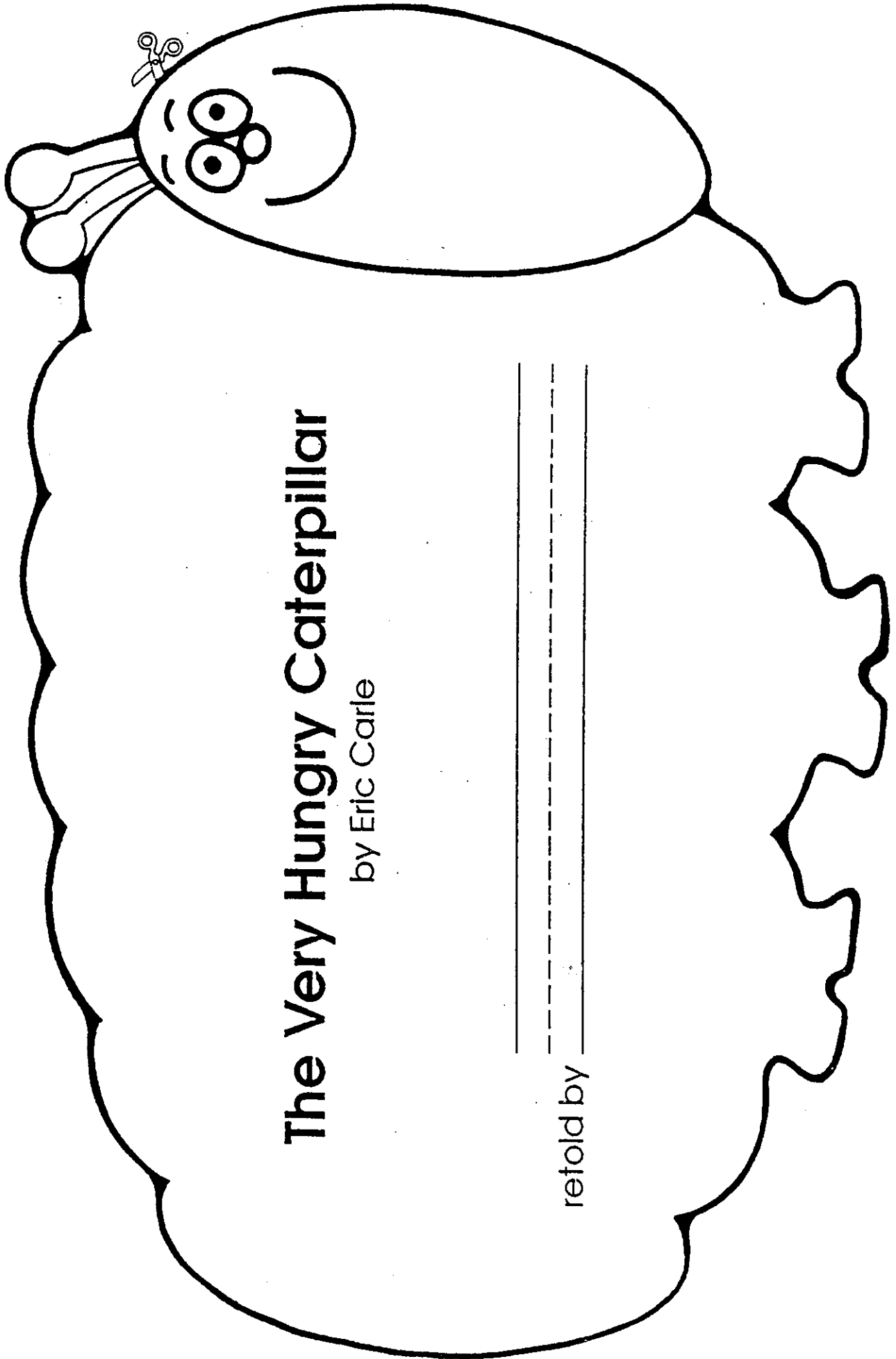

# The Very Hungry Caterpillar

by Eric Carle

\_\_\_\_\_

-----

\_\_\_\_\_

retold by \_\_\_\_\_



# Bulletin Board Pattern

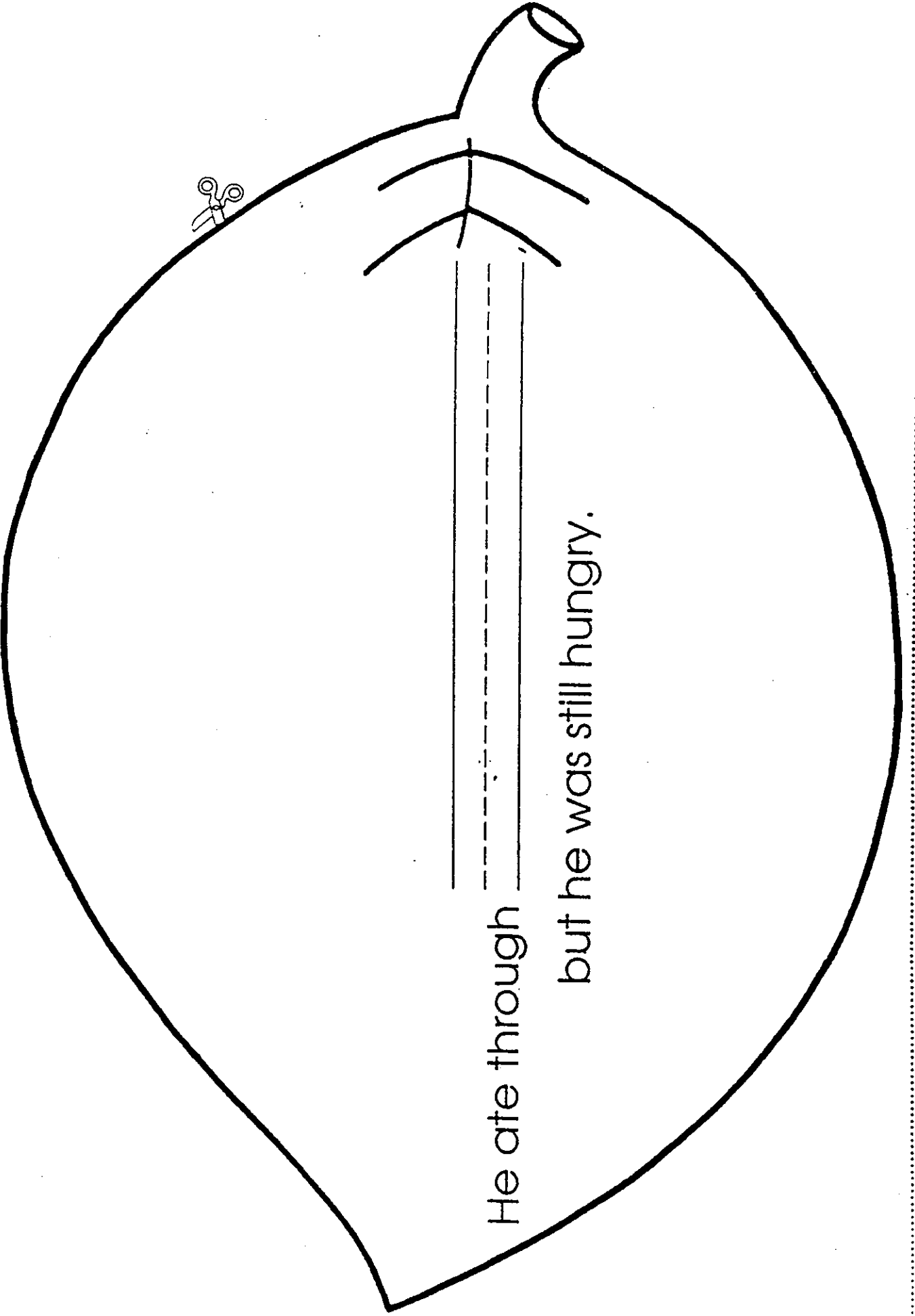

Teacher: Attach a real tree branch to the center of your bulletin board using thumbtacks and string. Or draw a tree branch on a large piece of butcher paper, cut it out, and pin it to the bulletin board. Duplicate this page on green construction paper. Have students cut out the leaf and write on it something the caterpillar ate. Then have students draw the food. Finally, have them make a caterpillar by gluing cotton balls, buttons, or crumpled tissue paper to their leaf. Hang the leaves around the tree branch for an eye-catching display.